

PCV 6-16/ 6-G1-10,16

Order No.: 1998823

The figure shows a 5-pos. version of the product

<http://eshop.phoenixcontact.de/phoenix/treeViewClick.do?UID=1998823>

Header, Nominal current: 76 A, Nom. voltage: 1000 V, Pitch: 10.16 mm, Number of positions: 6, Color: green, Assembly: Soldering

Commercial data

EAN	4046356038324
Pack	50 pcs.
Customs tariff	85366990
Weight/Piece	0.02616 KG
Catalog page information	Page 422 (CC-2009)

Product notes

WEEE/RoHS-compliant since:
05/18/2004

<http://www.download.phoenixcontact.com>
Please note that the data given here has been taken from the online catalog. For comprehensive information and data, please refer to the user documentation. The General Terms and Conditions of Use apply to Internet downloads.

Technical data

Dimensions / positions

Length	13.4 mm
Height	34 mm
Pitch	10.16 mm
Dimension a	50.8 mm
Number of positions	6

Pin dimensions	1 x 1.2 mm
Pin spacing	10.16 mm
Hole diameter	1.7 mm

Technical data

Insulating material group	I
Rated surge voltage (III/3)	6 kV
Rated surge voltage (III/2)	8 kV
Rated surge voltage (II/2)	8 kV
Rated voltage (III/2)	1000 V
Rated voltage (II/2)	1000 V
Connection in acc. with standard	EN-VDE
Nominal current I_N	76 A (41 A in combination with PC 6 plug)
Nominal voltage U_N	1000 V
Maximum load current	76 A (41 A in combination with PC 6 plug)
Insulating material	PA
Inflammability class acc. to UL 94	V0

Certificates / Approvals



Certification CB, CCA, CUL, SEV, UL

CUL

Nominal voltage U_N	600 V
Nominal current I_N	5 A

UL

Nominal voltage U_N	600 V
Nominal current I_N	5 A

Accessories

Item	Designation	Description
General		
1970016	CS-IPC 16/ 6	Coding pin, serves to ensure correct polarization on the PCB during manual mounting
Plug/Adapter		
1600027	CP-HCC 4	Coding profile, Color: red

Diagrams/Drawings

Drilling plan/solder pad geometry

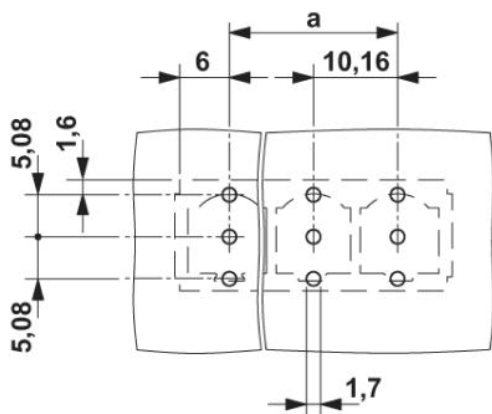

Diagram

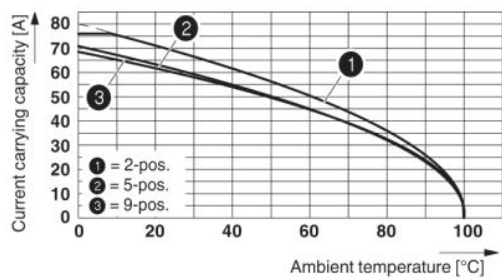

Dimensioned drawing

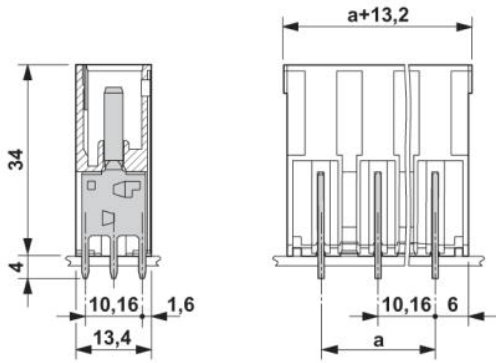

Address

PHOENIX CONTACT Inc., USA
586 Fulling Mill Road
Middletown, PA 17057, USA
Phone (800) 888-7388
Fax (717) 944-1625
<http://www.phoenixcon.com>



© 2010 Phoenix Contact
Technical modifications reserved;