

- NOTES:
- 1.MATERIALS:
1-1.HOUSING: SEE TABLE ,GLASS FIBER FILLED UL94V-0, COLOR: SEE TABLE.
1-2.CONTACT: SEE TABLE
 - 2.PLATING:
2-1.CONTACT AREA: GOLD, THICKNESS : SEE TABLE .
2-2.SOLDER TAIL: 100 MICRINCH MIN. TIN PLATING.
2-3.UNDER PLATING: NICKEL PLATING OVERALL.
 - 3.WEEK CODE: XX(YEAR) XXI(WEEK) X(LOCATION),
 - 4.PRODUCT SPECIFICATION REFER TO PS-87715-200.
 - 5.PACKAGING SPECIFICATION REFER TO PK-87715-207.
 - 6.TEST SUMMARY:REFER TO TS-87715-207.
 - 7.LEAD FREE AND ROHS COMPLIANCE PRODUCT.

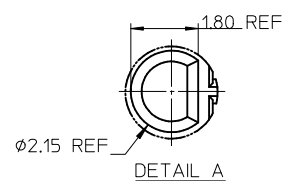
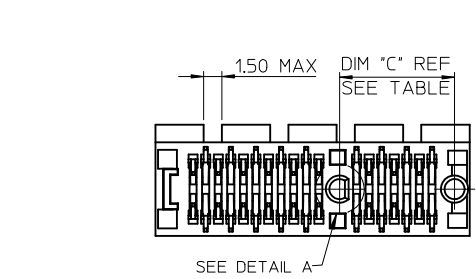
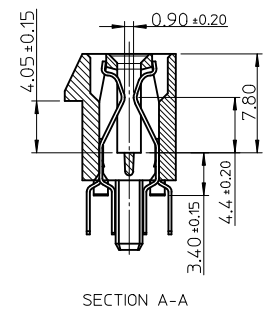
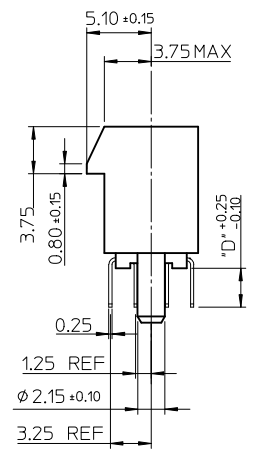
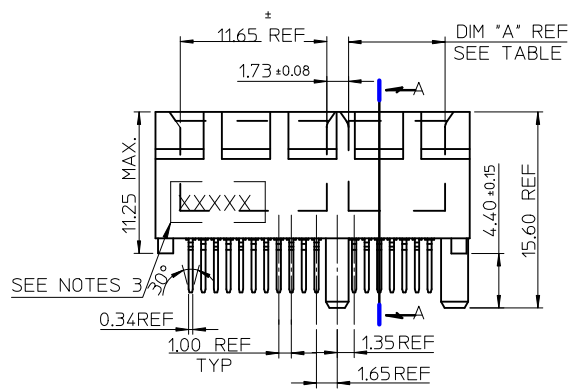

CONNECTOR LINK WIDTH	# POS REF	N	DIM 'A'	DIM 'B'	DIM 'C'
X1	36	6	7.65	25.00	9.15
X4	64	20	21.65	39.00	23.15
X8	98	37	38.65	56.00	40.15
X16	164	70	71.65	89.00	73.15

PCB THK (REF)	DIM 'D'
1.60	2.30
1.58	2.54
2.36	3.00

REVISED IEC NO: SH2010-0468 DRWNR:ZHANG 2010/06/15 CHKD:ALLEN L LIN 2004/07/20 APPR:X.J.SONG 2010/07/02	QUALITY SYMBOLS F=0 E=0 A=0	GENERAL TOLERANCES (UNLESS SPECIFIED)		DIMENSION STYLE MM ONLY		SCALE	DESIGN UNITS	THIRD ANGLE PROJECTION	
		4 PLACES	± ---	± ---	DRAWN BY	DATE	TITLE		PCI EXPRESS EDGE CARD CONNECTOR (LEAD FREE VERSION)
		3 PLACES	± ---	± ---	TOM	2004/07/20			
		2 PLACES	± 0.25	± ---	CHECKED BY	DATE	MOLEX INCORPORATED		
1 PLACE	± 0.25	± ---	ALLEN LIN	2004/07/20	DOCUMENT NO.		SHEET NO. 1 OF 4		
ANGULAR ± 3 °		APPROVED BY		DATE	SD-87715-207				
DRAFT WHERE APPLICABLE MUST REMAIN WITHIN DIMENSIONS		MATERIAL NO.		SEE SHEET 4		THIS DRAWING CONTAINS INFORMATION THAT IS PROPRIETARY TO MOLEX INCORPORATED AND SHOULD NOT BE USED WITHOUT WRITTEN PERMISSION			

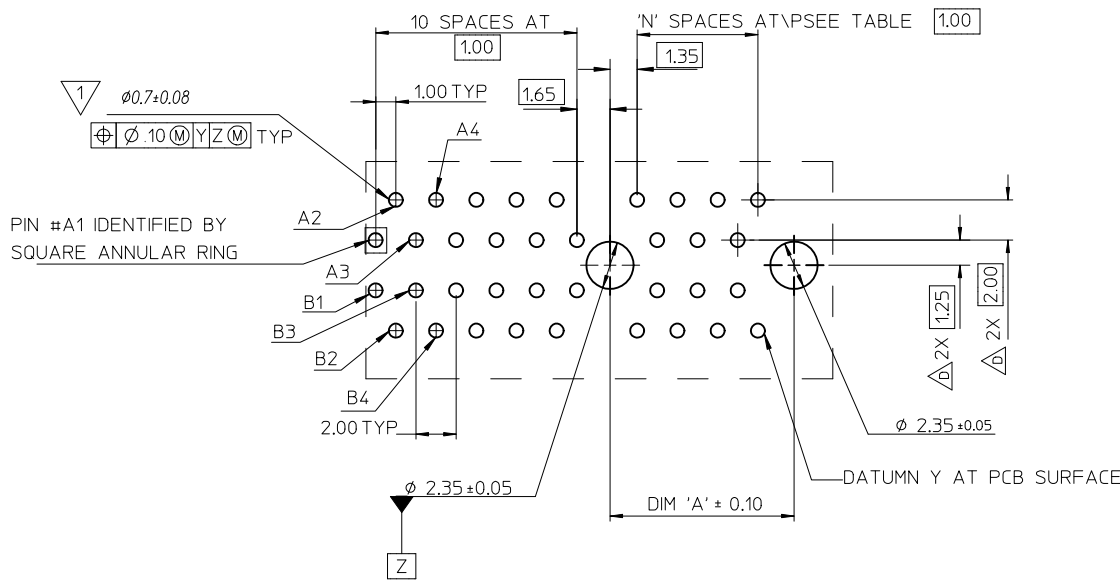

1 THE HORIZONTAL AXIS FOR THE HOLE PATTERN IS ESTABLISHED BY A LINE THROUGH THE CENTER OF THE TWO $\phi 2.35$ HOLES. THE VERTICAL AXIS IS 90° TO THE HORIZONTAL AXIS, THROUGH THE CENTER OF DATUM Z

PIN #A1 IDENTIFIED BY SQUARE ANNULAR RING

CONNECTOR LINK WIDTH	# POS REF	N	DIM 'A'
X1	36	6	9.15
X4	64	20	23.15
X8	98	37	40.15
X16	164	70	73.15

SEE SHEET 1 EC NO: SH2010-0468 DRAWN: ZHANG 2010/06/15 CHKD: ALLEN LIN 2004/07/20 APPR: XJSONG 2010/07/02	QUALITY SYMBOLS $F_A=0$ $F_G=0$ $F_P=0$	GENERAL TOLERANCES (UNLESS SPECIFIED) mm INCH 4 PLACES ± --- ± --- 3 PLACES ± --- ± --- 2 PLACES ± 0.25 ± --- 1 PLACE ± 0.25 ± --- ANGULAR ± 3°	DIMENSION STYLE MM ONLY DRAWN BY: TOM DATE: 2004/07/20 CHECKED BY: ALLEN LIN DATE: 2004/07/20 APPROVED BY: WILSON DATE: 2004/07/20 MATERIAL NO.	SCALE DESIGN UNITS METRIC THIRD ANGLE PROJECTION	TITLE PCI EXPRESS EDGE CARD CONNECTOR (LEAD FREE VERSION) MOLEX INCORPORATED DOCUMENT NO. SD-87715-207 SHEET NO. 2 OF 4	
	DRAFT WHERE APPLICABLE MUST REMAIN WITHIN DIMENSIONS	SEE SHEET 4	THIS DRAWING CONTAINS INFORMATION THAT IS PROPRIETARY TO MOLEX INCORPORATED AND SHOULD NOT BE USED WITHOUT WRITTEN PERMISSION			
	SIZE A3					

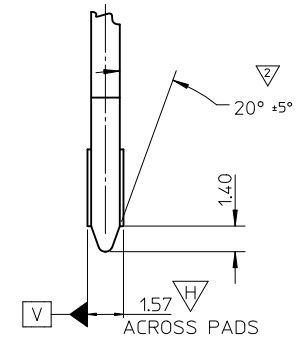
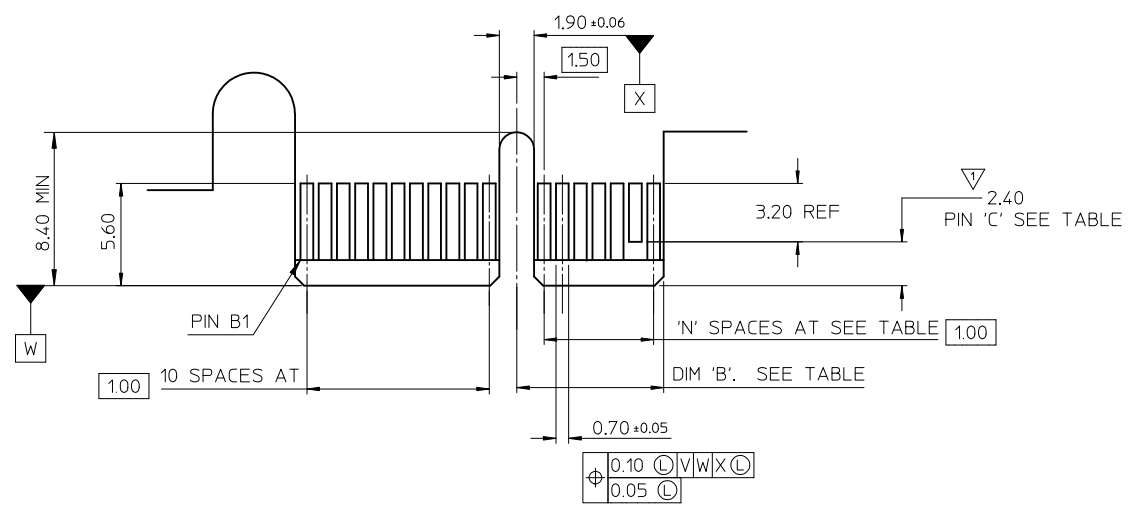

← I/O PANEL DIRECTION

PRIMARY (COMPONENT) SIDE

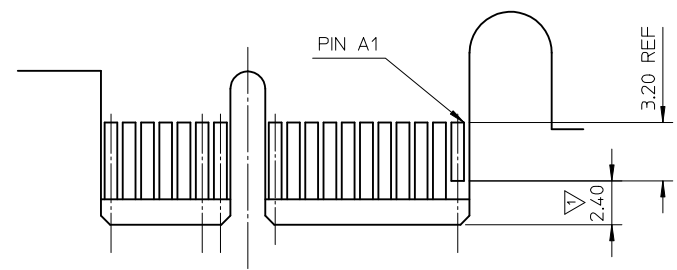

I/O PANEL DIRECTION →

SECONDARY (SOLDER) SIDE

- 1 NO TIE BAR PERMITTED FROM CARD EDGE TO LEADING EDGE OF PAD FOR PINS A1 AND "C".
- 2 CHAMFER EDGES MUST BE FREE OF CUTTING BURRS.
- 3. TOLERANCE: .XX±.13

CONNECTOR LINK WIDTH	# POS REF	N	DIM 'B'	'C' Δ
X1	36	6	8.15	B17
X4	64	20	22.15	B17, B31
X8	98	37	39.15	B17, B31 B48
X16	164	70	72.15	B17, B31 B48, B81

SEE SHEET 1 EC NO: SH2010-0468 DRWR: ZHANG 2010/06/15 CHKD: ALLEN LIN 2004/07/20 APPR: X.J.SONG 2010/07/02	QUALITY SYMBOLS	GENERAL TOLERANCES (UNLESS SPECIFIED)	DIMENSION STYLE	SCALE	DESIGN UNITS	THIRD ANGLE PROJECTION	
	$\nabla_{\text{A}}=0$	mm INCH	MM ONLY		METRIC		
	$\nabla_{\text{B}}=0$	4 PLACES ± --- ± ---	DRAWN BY DATE	TITLE			
	$\nabla_{\text{C}}=0$	3 PLACES ± --- ± ---	TOM 2004/07/20	PCI EXPRESS EDGE CARD CONNECTOR (LEAD FREE VERSION)			
	2 PLACES ± 0.25 ± ---	CHECKED BY DATE	MOLEX MOLEX INCORPORATED				
	1 PLACE ± 0.25 ± ---	ALLEN LIN 2004/07/20	MATERIAL NO. DOCUMENT NO.				
	ANGULAR ± 3°	APPROVED BY DATE	SEE SHEET 4 SD-87715-207				
		WILSON 2004/07/20	SHEET NO. 3 OF 4				
			THIS DRAWING CONTAINS INFORMATION THAT IS PROPRIETARY TO MOLEX INCORPORATED AND SHOULD NOT BE USED WITHOUT WRITTEN PERMISSION				

MOLEX P/N	CIRCUIT SIZE	HOUSING MATERIAL	HOUSING COLOR	TERMINAL MATERIAL	CONTACT PLATING	SOLDER TAIL 'D' LENGTH	
87715-9001	36	NYLON46	BLACK	PHOSPHOR BRONZE	10 MICROINCH	2.54	
87715-9003					GOLD FLASH		
87715-9004					10 MICROINCH	3.00	
87715-9007					GOLD FLASH		
87715-9008					15 MICROINCH		2.30

MOLEX P/N	CIRCUIT SIZE	HOUSING MATERIAL	HOUSING COLOR	TERMINAL MATERIAL	CONTACT PLATING	SOLDER TAIL 'D' LENGTH
87715-9100	64	NYLON46	BLACK	PHOSPHOR BRONZE	GOLD FLASH	2.54
87715-9101					10 MICROINCH	
87715-9102					15 MICROINCH	3.00
87715-9103					GOLD FLASH	
87715-9104					10 MICROINCH	
87715-9105					15 MICROINCH	
87715-9106					30 MICROINCH	2.54
87715-9107					GOLD FLASH	2.30
87715-9108					15 MICROINCH	
87715-9109					30 MICROINCH	

MOLEX P/N	CIRCUIT SIZE	HOUSING MATERIAL	HOUSING COLOR	TERMINAL MATERIAL	CONTACT PLATING	SOLDER TAIL 'D' LENGTH
87715-9200	98	NYLON46	BLACK	PHOSPHOR BRONZE	GOLD FLASH	2.54
87715-9201					10 MICROINCH	
87715-9202					15 MICROINCH	3.00
87715-9203					GOLD FLASH	
87715-9204					10 MICROINCH	
87715-9205					15 MICROINCH	
87715-9206					30 MICROINCH	2.54
87715-9207					GOLD FLASH	2.30
87715-9208					15 MICROINCH	
87715-9209					30 MICROINCH	

MOLEX P/N	CIRCUIT SIZE	HOUSING MATERIAL	HOUSING COLOR	TERMINAL MATERIAL	CONTACT PLATING	SOLDER TAIL 'D' LENGTH
87715-9602	98	NYLON46	BLACK	BRASS	15 MICROINCH	2.54

MOLEX P/N	CIRCUIT SIZE	HOUSING MATERIAL	HOUSING COLOR	TERMINAL MATERIAL	CONTACT PLATING	SOLDER TAIL 'D' LENGTH
87715-9301	164	NYLON46	BLACK	PHOSPHOR BRONZE	10 MICROINCH	2.54
87715-9304						3.00
87715-9307					GOLD FLASH	2.30
87715-9308					15 MICROINCH	

SEE SHEET 1 EC NO: SH2010-0468 DRWNR:ZHANG 2010/06/15 CHKD:ALLEN LIN 2004/07/20 APPR:XJ.SONG 2010/07/02	QUALITY SYMBOLS	GENERAL TOLERANCES (UNLESS SPECIFIED)		DIMENSION STYLE MM ONLY		SCALE	DESIGN UNITS METRIC	THIRD ANGLE PROJECTION
	$F_A=0$	4 PLACES	mm	INCH	DRAWN BY	DATE	TITLE	
	$F_C=0$	3 PLACES	± ---	± ---	TOM	2004/07/20	PCI EXPRESS	
	$F_P=0$	2 PLACES	± 0.25	± ---	CHECKED BY	DATE	EDGE CARD CONNECTOR (LEAD FREE VERSION)	
	1 PLACE	± 0.25	± ---	ALLEN LIN	2004/07/20	MOLEX INCORPORATED		
		ANGULAR ± 3 °		APPROVED BY	DATE	DOCUMENT NO.		
		DRAFT WHERE APPLICABLE MUST REMAIN WITHIN DIMENSIONS		WILSON	2004/07/20	SD-87715-207		
				MATERIAL NO.		SHEET NO.		
				SEE TABLE		4 OF 4		
				SIZE A3	THIS DRAWING CONTAINS INFORMATION THAT IS PROPRIETARY TO MOLEX INCORPORATED AND SHOULD NOT BE USED WITHOUT WRITTEN PERMISSION			