

## CDST-99-HF/70-HF/56-HF

Reverse Voltage: 70 Volts

Forward Current: 200 mA

RoHS Device

Halogen Free

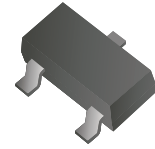

### Features

- Design for mounting on small surface.
- High speed switching.
- High mounting capability, strong surge withstand, high reliability.

### Mechanical data

- Case: SOT-23, molded plastic.
- Terminals: solderable per MIL-STD-750, method 2026.
- Approx. weight: 0.0078 grams

### Circuit diagram

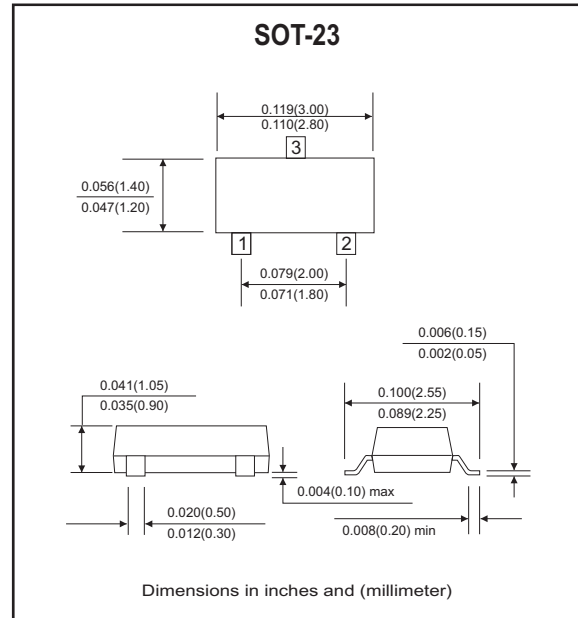
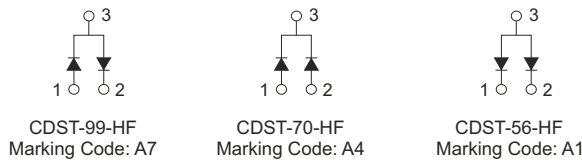

### Maximum Ratings (at Ta=25°C unless otherwise noted)

Parameter	Symbol	Value	Units
Reverse voltage	$V_R$	70	V
Forward current	$I_F$	200	mA
Peak surge forward current	$I_{FSM}$	500	mA
Power dissipation	$P_D$	225	mW
Thermal resistance, junction to ambient	$R_{\theta JA}$	556	°C/W
Maximum junction temperature	$T_J$	150	°C
Storage temperature	$T_{STG}$	-55 to +150	°C

### Electrical Characteristics (at Ta=25°C unless otherwise noted)

Parameter	Symbol	Conditions	Min.	Max.	Units
Reverse breakdown voltage	$V_{BR}$	$I_R=100\mu A$	70		V
Forward voltage	$V_F$	@ $I_F=1mA$ @ $I_F=10mA$ @ $I_F=50mA$ @ $I_F=150mA$		0.715 0.855 1.0 1.25	V
Reverse current	$I_R$	@ $V_R=70V$		2.5	$\mu A$
Reverse recovery time	$t_{rr}$	$I_F=I_R=10mA, I_{rr}=0.1 \times I_R, R_L=100\Omega$		6	nS
Diode capacitance	$C_T$	$V_R=0V, f=1.0MHz$		1.5	pF

## RATING AND CHARACTERISTIC CURVES (CDST-99-HF/70-HF/56-HF)

Fig.1 - Forward Characteristics

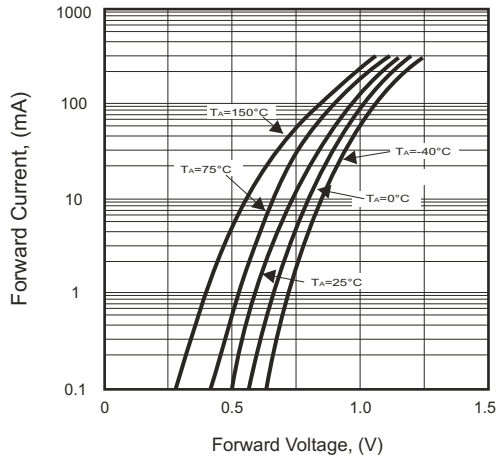

Fig.2 - Reverse Characteristics

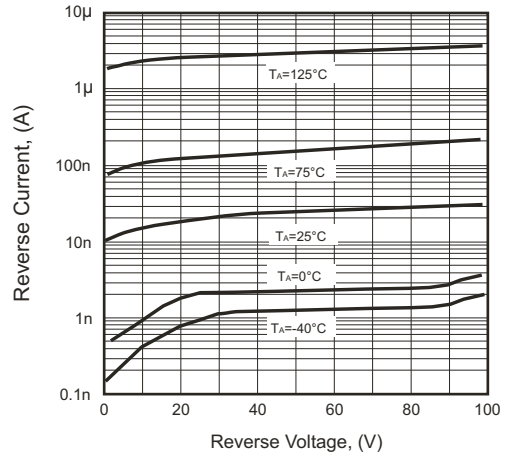

Fig.3 - Capacitance Between Terminals Characteristics

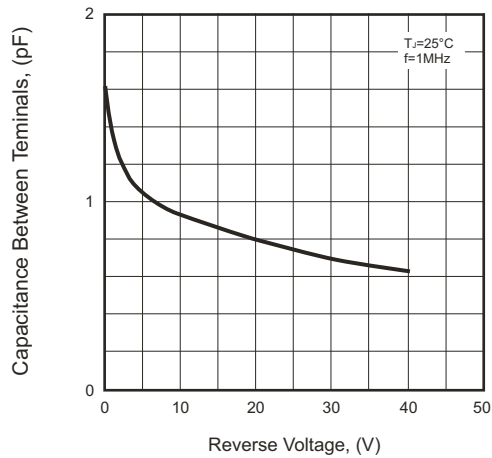
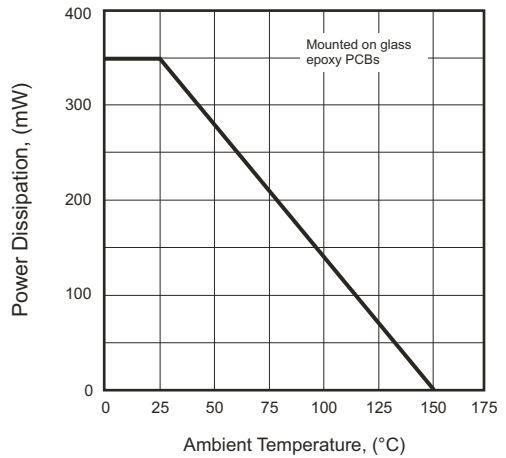
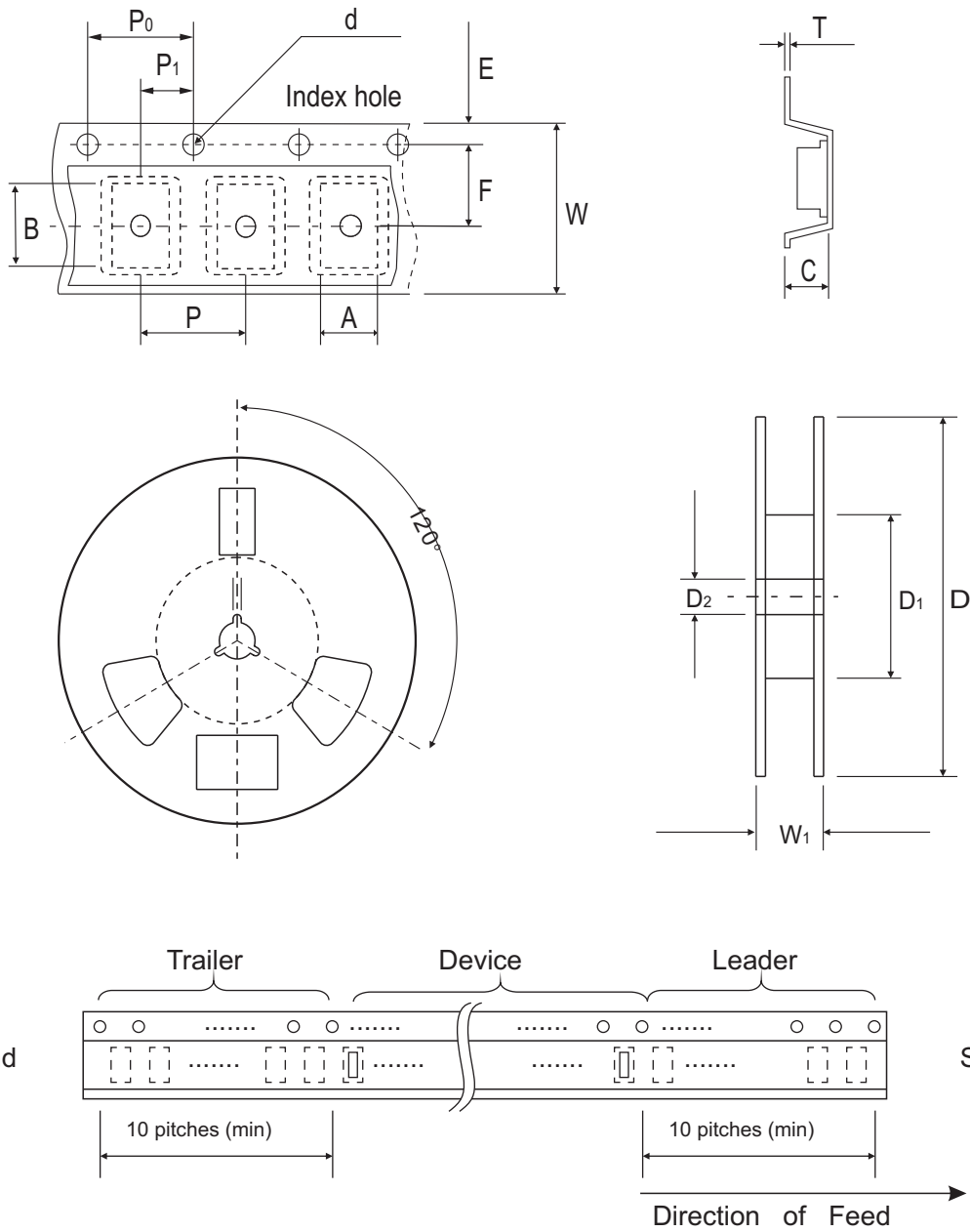

Fig.4 - Power Derating Curve



## Reel Taping Specification



SOT-23	SYMBOL	A	B	C	d	D	D1	D2
	(mm)	3.10 ± 0.10	2.85 ± 0.10	1.40 ± 0.10	1.55 ± 0.10	178 ± 1.00	54.00 (min)	13.00 ± 0.20
	(inch)	0.122 ± 0.004	0.112 ± 0.004	0.055 ± 0.004	0.061 ± 0.004	7.008 ± 0.039	1.969 (min)	0.512 ± 0.008

SOT-23	SYMBOL	E	F	P	P0	P1	W	W1
	(mm)	1.75 ± 0.10	3.50 ± 0.05	4.00 ± 0.10	4.00 ± 0.10	2.00 ± 0.05	8.00 ± 0.30	14.40 (max)
	(inch)	0.069 ± 0.004	0.138 ± 0.002	0.157 ± 0.004	0.157 ± 0.004	0.079 ± 0.002	0.315 ± 0.012	0.567 (max)

## Marking Code

Part Number	Marking Code
CDST-99-HF	A7
CDST-70-HF	A4
CDST-56-HF	A1

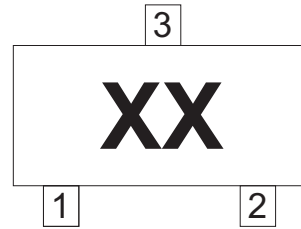

XX = Product type marking code

## Suggested PAD Layout

SIZE	SOT-23	
	(mm)	(inch)
A	0.80	0.031
B	1.90	0.075
C	2.02	0.080
D	2.82	0.111

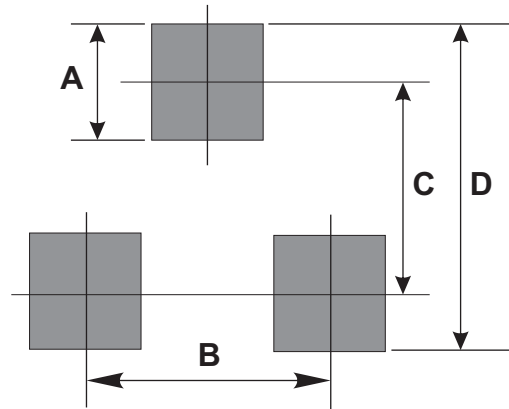

## Standard Packaging

Case Type	REEL PACK	
	REEL ( pcs )	Reel Size (inch)
SOT-23	3,000	7