

QT-Brightek Chip LED Series

0402 SMD Chip LED

Part No.: QBLP595-IW

Table of Contents:

Introduction	3
Electrical / Optical Characteristic (Ta=25 °C)	4
Absolute Maximum Rating	4
Correlated Color Temperature Chart	5
Characteristic Curves.....	6
Solder Profile & Footprint.....	7
Packing	8
Labeling	9
Ordering Information	9
Revision History	10
Disclaimer	10

Introduction

Feature:

- Diffused lens
- Package in tape and reel
- Compact 0402 package
- InGaN technology for IW
- Viewing Angle: 150° typ.

Description:

These compact 0402 LEDs have a height profile of 0.5mm. Combination of high brightness output and small footprint, these LEDs are ideal for keypad backlighting and status indication.

Application:

- Status indication
- Back lighting application

Certification & Compliance:

- ISO9001
- RoHS Compliant



Dimension:

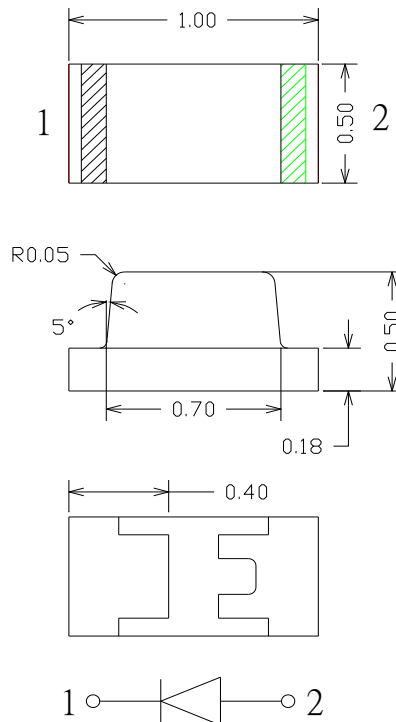

Units: mm / tolerance = +/-0.1mm

Electrical / Optical Characteristic (Ta=25 °C)

Product	Color	I _F (mA)	V _F (V)		CCT Coordinate			I _V (mcd)	
			Typ.	Max.	Min.	Typ.	Max.	Min.	Typ.
QBLP595-IW	White	20	3.2	3.7	-	X=0.345 Y=0.353	-	125	210

Absolute Maximum Rating

Material	P _d (mW)	I _F (mA)	I _{FP} (mA)*	V _R (V)	T _{OP} (°C)	T _{ST} (°C)	T _{SO L} (°C)**
InGaN	111	30	125	5	-40 ~ +80	-40 ~ +85	260

*Duty 1/8 @ 1KHz

**IR Reflow for no more than 10 sec @ 260 °C

Forward Voltage V_F @ I_F=20mA

Bin	Min.	Max.	Unit
f	2.8	3.1	V
g	3.1	3.4	
h	3.4	3.7	

Luminous Intensity I_V @ I_F=20mA

Bin	Min.	Max.	Unit
K	125	160	mcd
L	160	200	
M	200	250	
N	250	320	
O	320	400	

Note:

Tolerance of measurement of forward voltage: ±0.1V

Tolerance of measurement of luminous intensity: ±15%

Correlated Color Temperature Chart

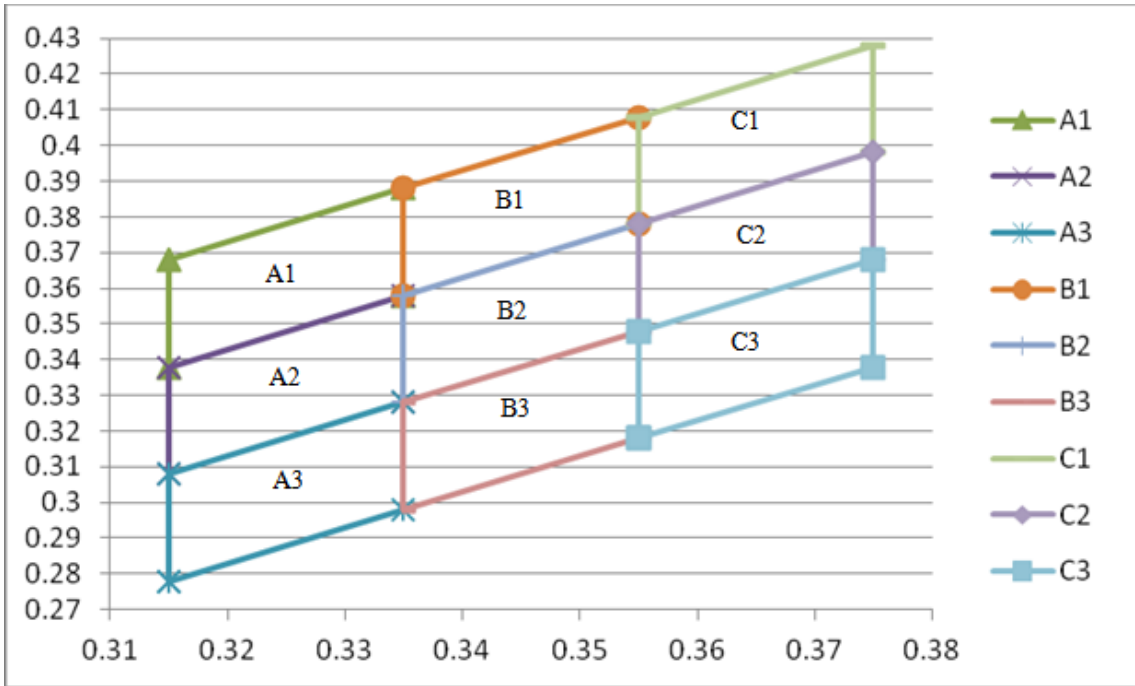

Rank	Chromaticity coordinates				
		X	Y	X	Y
A1	X	0.315	0.335	0.315	0.335
	Y	0.338	0.358	0.368	0.388
A2	X	0.315	0.335	0.315	0.335
	Y	0.308	0.328	0.338	0.358
A3	X	0.315	0.335	0.315	0.335
	Y	0.278	0.298	0.308	0.328
B1	X	0.335	0.355	0.335	0.355
	Y	0.358	0.378	0.388	0.408
B2	X	0.335	0.355	0.335	0.355
	Y	0.328	0.348	0.358	0.378
B3	X	0.335	0.355	0.335	0.355
	Y	0.298	0.318	0.328	0.348
C1	X	0.355	0.375	0.355	0.375
	Y	0.378	0.398	0.408	0.428
C2	X	0.355	0.375	0.355	0.375
	Y	0.348	0.368	0.378	0.398
C3	X	0.355	0.375	0.355	0.375
	Y	0.318	0.338	0.348	0.368

Note:
Tolerance of measurement of color coordinates: ± 0.01

Characteristic Curves

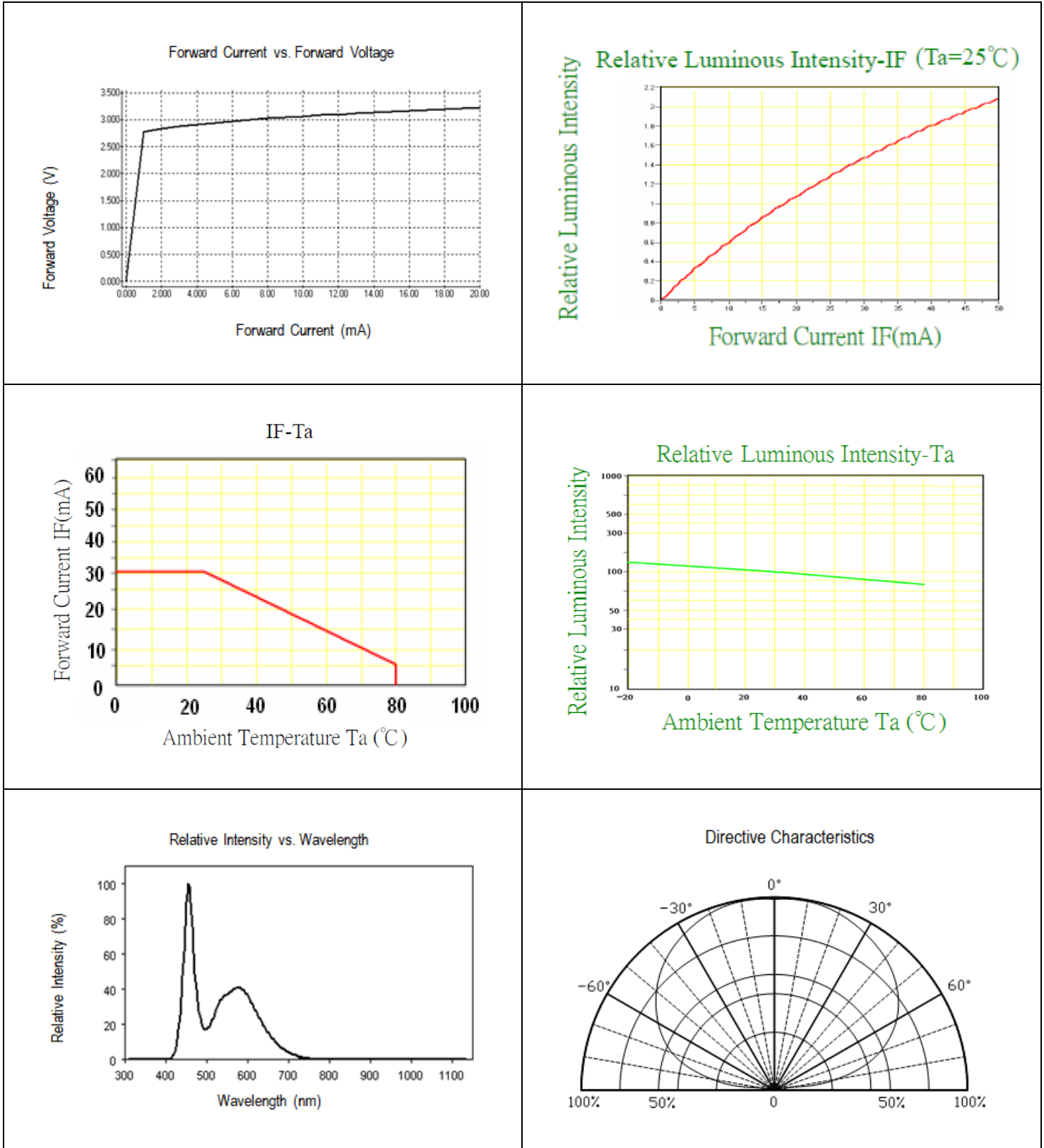

Solder Profile & Footprint

-The recommended reflow soldering profile is as follows (temperatures indicated are as measured on the surface of the LED resin):

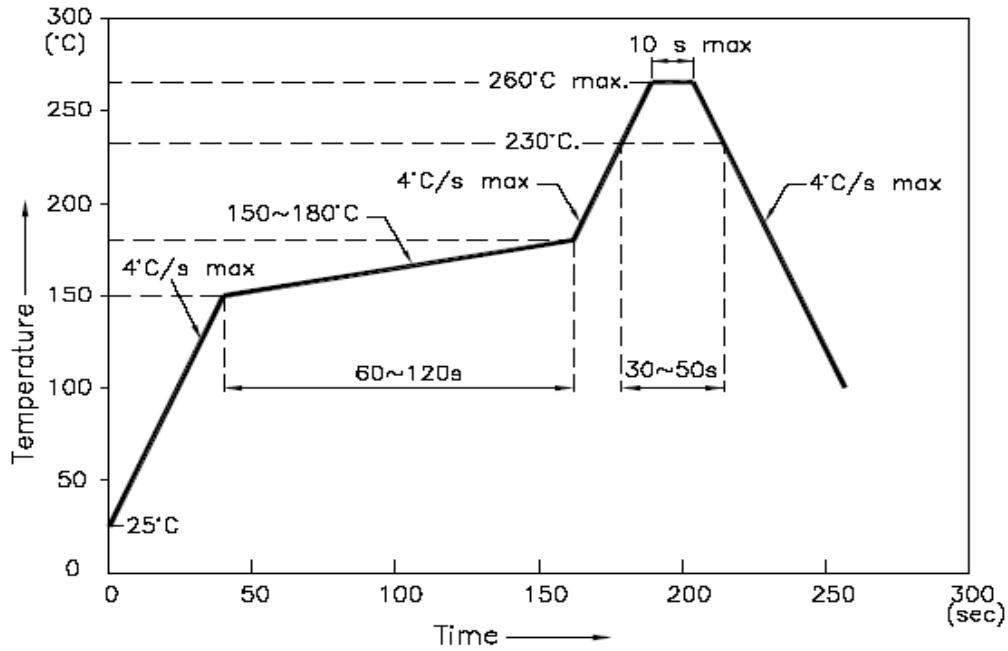

Recommended Pad Layout

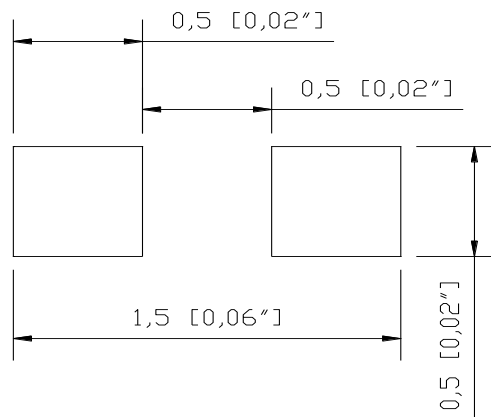

Units: mm

Tolerance: ±0.1mm

Packing

Reel Dimension:

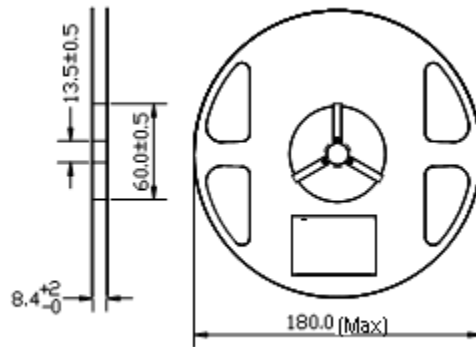

(Unit: mm)

Tape Dimension:

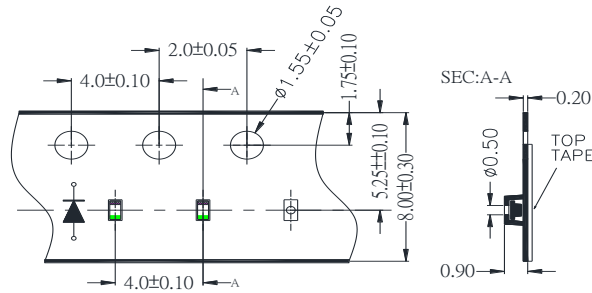

(Unit: mm)

Arrangement of Tape:

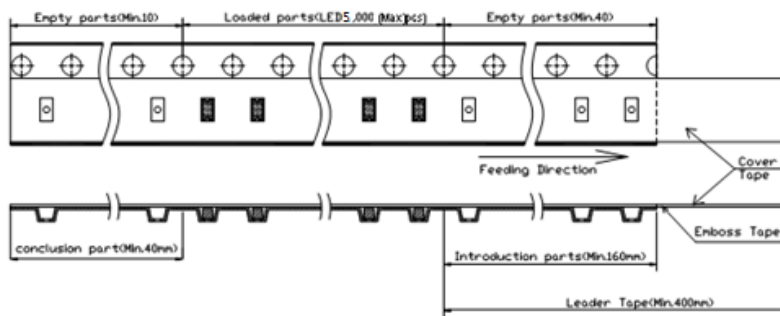

Packaging Specifications:

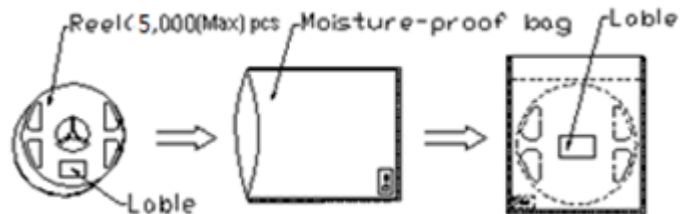

Labeling

Part No: _____

Customer P/N: _____

Item: _____

Q'ty: _____

Vf: _____

Iv: _____

WI: _____

Date: _____

Made in China**Ordering Information**

Part #	Orderable Part #	Spec Range	Quantity per reel
QBLP595-IW	QBLP595-IW	Iv=210mcd typ. @ If=20mA / CCT: (X=0.345, Y=0.353) typ.	5,000 units

Revision History

Description:	Revision #	Revision Date
New Release of QBLP595-IW	V1.0	10/20/2017

Disclaimer

QT-BRIGHTTEK reserves the right to make changes without further notice to any products herein to improve reliability, function or design. QT-BRIGHTTEK does not assume any liability arising out of the application or use of any product or circuit described herein; neither does it convey any license under its patent rights, nor the rights of others.

Life Support Policy

QT-BRIGHTTEK's products are not authorized for use as critical components in life support devices or systems without the express written approval of QT-BRIGHTTEK. As used herein:

1. Life support devices or systems are devices or systems which, (a) are intended for surgical implant into the body, or (b) support or sustain life, and (c) whose failure to perform when properly used in accordance with instructions for use provided in the labeling, can be reasonably expected to result in a significant injury of the user.
2. A critical component in any component of a life support device or system whose failure to perform can be reasonably expected to cause the failure of the life support device or system, or to affect its safety or effectiveness.