

ADC 3 click

2. Soldering the headers

Before using your click board™, make sure to solder 1x8 male headers to both left and right side of the board. Two 1x8 male headers are included with the board in the package.

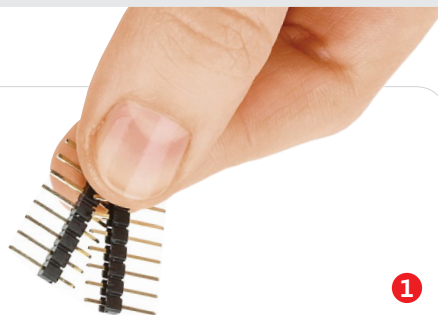

2

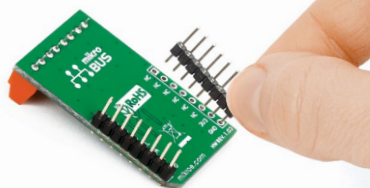

Turn the board upside down so that the bottom side is facing you upwards. Place shorter pins of the header into the appropriate soldering pads.

3

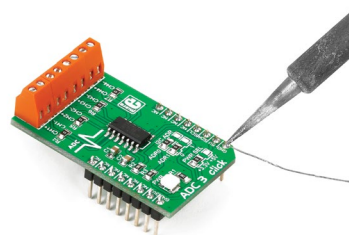

Turn the board upward again. Make sure to align the headers so that they are perpendicular to the board, then solder the pins carefully.

1. Introduction

ADC3 click carries Microchip's **MCP3428 16-bit** multichannel analog-to-digital converter. The click has four pairs of screw terminals onboard, letting you access the chip's four differential input channels. A pair of onboard jumpers allow switching between different I2C addresses. ADC3 click communicates with the target MCU through mikroBUS I2C pins [SCL, SDA]. It is designed to use either a 3.3V or 5V power supply.

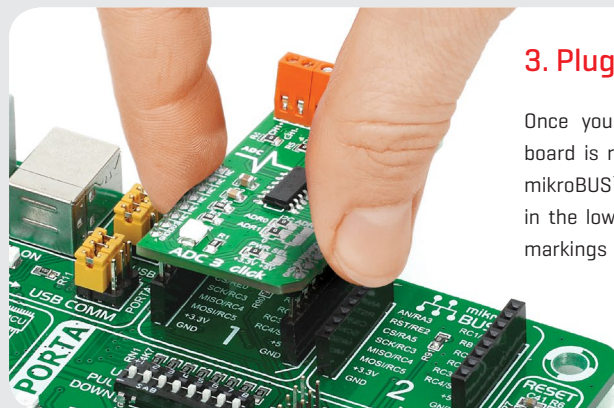

3. Plugging the board in

Once you have soldered the headers your board is ready to be placed into the desired mikroBUS™ socket. Make sure to align the cut in the lower-right part of the board with the markings on the silkscreen at the mikroBUS™ socket. If all the pins are aligned correctly, push the board all the way into the socket.

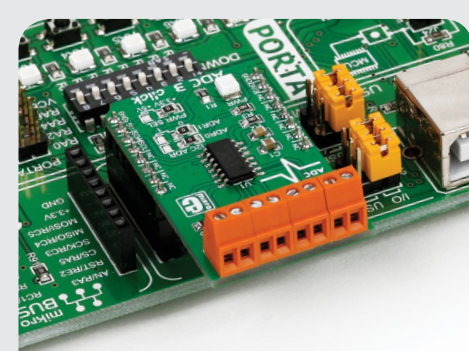

4. Essential features

ADC3 click can be configured in different ways depending whether accuracy or speed is your primary concern. At the highest resolution of 16-bits, the chip outputs conversion results at 15 samples per second. At 14-bits, the sample rate is 60 SPS. Maximum conversion speed is achieved in 12-bit mode, 240 samples per second. The I2C interface also has standard, fast and high speed modes. The chip automatically calibrates offset and gain errors. A built-in gain amplifier allows you to convert weak signals [up to x8 amplification].

click
BOARD™
www.mikroe.com



ADC 3 click Manual v100



010000087527

5. Schematic

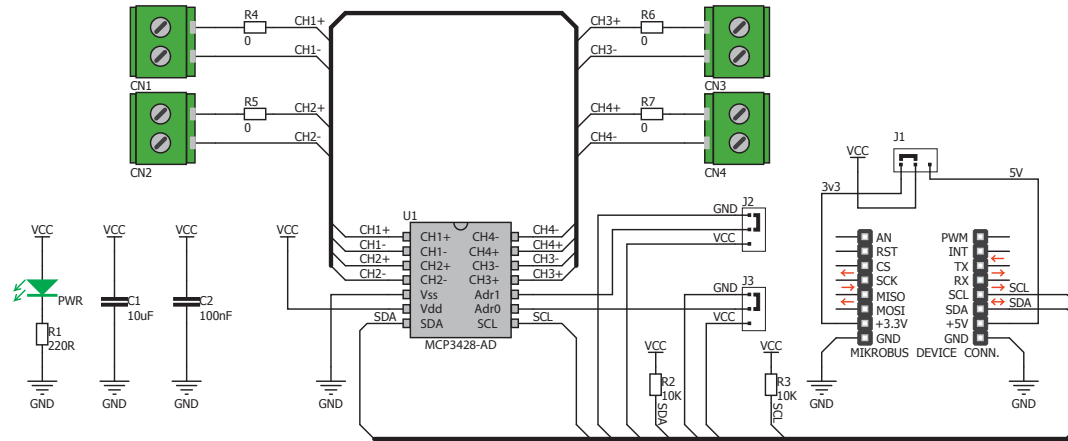

6. Dimensions

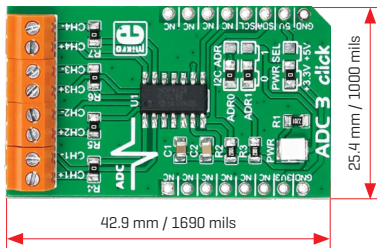

	mm	mils
LENGTH	42.9	1690
WIDTH	25.4	1000
HEIGHT*	3.9	154

* without headers

7. SMD jumpers



ADC3 click features an SMD jumper (zero ohm resistor) that let's you switch between a 3.3V or a 5V power supply. The pair of jumpers above it is for configuring the I2C address.

8. Code examples

Once you have done all the necessary preparations, it's time to get your click board™ up and running. We have provided examples for mikroC™, mikroBasic™ and mikroPascal™ compilers on our **Libstock** website. Just download them and you are ready to start.



9. Support

MikroElektronika offers **free tech support** [www.mikroe.com/support] until the end of the product's lifetime, so if something goes wrong, we're ready and willing to help!



10. Disclaimer

MikroElektronika assumes no responsibility or liability for any errors or inaccuracies that may appear in the present document. Specification and information contained in the present schematic are subject to change at any time without notice.

Copyright © 2015 MikroElektronika.
All rights reserved.