

MAX11043ATL Evaluation Kit

Evaluates: MAX11043

General Description

The MAX11043ATL evaluation kit (EV kit) provides a proven design to evaluate the MAX11043 4-channel, 16-bit, simultaneous-sampling ADCs. The EV kit also includes Windows XP®, Windows Vista®, and Windows® 7-compatible software that provides a simple graphical user interface (GUI) for exercising the features of the IC. The EV kit is installed with a MAX11043ATL+ in a 40-pin TQFN package with an exposed pad.

[Ordering Information](#) appears at end of data sheet

Features

- ◆ 40MHz SPI Interface
- ◆ Windows XP-, Windows Vista-, and Windows 7-Compatible Software
- ◆ Time Domain and FFT Plotting in the EV Kit Software
- ◆ Collects Up to 4 Mega Samples for Each of the 4 Channels
- ◆ USB-PC Connection
- ◆ Proven PCB Layout
- ◆ Fully Assembled and Tested

Component List

DESIGNATION	QTY	DESCRIPTION
AGND, DGND, TP17	3	Black multipurpose test points
BC5–BC18, BC20–BC29, BC40–BC56	41	0.1µF ±10%, 16V X5R ceramic capacitors (0402) Murata GRM155R61C104K
C1–C8, C18–C21, C49–C54, C69, C71, C73	21	1µF ±10%, 16V X7R ceramic capacitors (0603) Murata GRM188R71C105K
C9–C17, C23–C30, C47, C48, C60, C63	21	10µF ±10%, 10V X7R ceramic capacitors (0805) Murata GRM21BR71A106K
C22, C55, C56, C57, C62, C65, C68, C70, C72, C74–C77	13	0.1µF ±10%, 16V X7R ceramic capacitors (0603) Murata GRM188R71C104K
C31–C34	4	2200pF ±10%, 50V C0G ceramic capacitors (0603) Murata GRM1885C1H222K
C46	1	100µF ±20%, 6.3V X5R ceramic capacitor (1210) Murata GRM32ER60J107M
C58, C59	2	22pF ±5%, 50V C0G ceramic capacitors (0603) Murata GRM1885C1H220J

DESIGNATION	QTY	DESCRIPTION
C61, C64	2	1000pF ±10%, 50V X7R ceramic capacitors (0603) Murata GRM188R71H102K
C66	1	0.47µF ±10%, 10V X5R ceramic capacitor (0603) Murata GRM188R61A474K
C67	1	100pF ±5%, 50V C0G ceramic capacitor (0603) Murata GRM1885C1H101J
CONVRUN, CS, DACSTEP, DIN, DOUT, EOC, SCLK, SHDN, TP14, TP15, UP/DWN	11	Yellow multipurpose test points
D1	1	Hyper-bright, low-current green LED (0603)
D2–D5	4	Hyper-bright, low-current red LEDs (0603)
EXT_AVDD, EXT_DVDD, TP16	3	Red multipurpose test points
FB1, FB2, FB3	3	0.1Ω DCR, 60Ω at 100MHz ferrite beads (0603) TDK MMZ1608R600A

Windows, Windows XP, and Windows Vista are registered trademarks of Microsoft Corp.

MAX11043ATL Evaluation Kit

Evaluates: MAX11043

Component List (continued)

DESIGNATION	QTY	DESCRIPTION
J1	1	12-position terminal block
J2	1	6-position terminal block
J3	1	10-pin (2 x 5) dual-row header
J4	1	Mini USB type-AB, right-angle receptacle
J5	1	2-position terminal block
JU1–JU14, JU20–JU27	22	2-pin headers
JU16–JU19	4	3-pin headers
Q1	1	n-channel low-threshold voltage MOSFET (SOT523F)
R1, R2	2	0.1 Ω \pm 1%, 1/2W sensing resistors (1206)
R3	1	47k Ω \pm 5% resistor (0603)
R4	1	12.1k Ω \pm 1% resistor (0603)
R5, R10–R13	5	10k Ω \pm 5% resistors (0603)
R6	1	10 Ω \pm 5% resistor (0603)
R7, R8, R9	3	1k Ω \pm 5% resistors (0603)
R14, R61–R64	5	160 Ω \pm 5% resistors (0603)
R15	1	0 Ω \pm 5% resistor (0805)
R31–R38	8	22 Ω \pm 5%, 8-element chip resistor networks (0603 x 8)
R39	1	22 Ω \pm 5% resistor (0603)
R40–R54	15	5.1k Ω \pm 5% resistors (0603)
R55–R60	6	100k Ω \pm 5% resistors (0603)
SW1–SW6	6	Light-touch switches
U1	1	4-channel, 16-bit simultaneous-sampling ADCs (40 TQFN-EP*) Maxim MAX11043ATL+
U2	1	3.3V LDO Maxim MAX1793EUE33+
U3	1	2.5V LDO Maxim MAX1793EUE25+

DESIGNATION	QTY	DESCRIPTION
U4	1	1.8V LDO Maxim MAX1793EUE18+
U5	1	1.2V LDO Maxim MAX1982EUT+
U6	1	2.5V high-precision reference generator (8 SO) Maxim MAX6126AASA25+
U7	1	Cyclone III FPGA (324 FBGA) Altera EP3C25F324C8N
U8	1	Ultra-precision high-side current-sense amplifier (10 μ MAX®) Maxim MAX9923HEUB+
U9	1	256K x 36-bit SSRAM (100 TQFP)
U10	1	16M x 16-bit flash memory (64 Easy BGA)
U11	1	Ultra-precision, high-side current-sense amplifier (10 μ MAX) Maxim MAX9923FEUB+
U12	1	ULPI Hi-Speed USB 2.0 OTG transceiver (32 HVQFN-EP*)
Y1	1	16MHz crystal Epson MA-505 16.0000M-C0:ROHS
Y2	1	50MHz clock oscillator Hong Kong X'tals C4M50000NSMi02601-0
—	26	Shunts
—	1	PCB: MAX11043 EVALUATION KIT

*EP = Exposed pad.

Component Suppliers

SUPPLIER	PHONE	WEBSITE
Altera Corp.	800-800-3753	www.altera.com
Hong Kong X'tals Ltd.	852-35112388	www.hongkongcrystal.com
Murata Electronics North America Inc.	770-436-1300	www.murata-northamerica.com
TDK Corp.	847-803-6100	www.component.tdk.com

Note: Indicate that you are using the MAX11043 when contacting these component suppliers.

μ MAX is a registered trademark of Maxim Integrated Products, Inc.

MAX11043ATL Evaluation Kit

Evaluates: MAX11043

MAX11043 EV Kit Files

FILE	DESCRIPTION
INSTALL.EXE	Installs the EV kit files on your computer
MAX11043EVKIT.EXE	Application program
UNINSTALL.EXE	Uninstalls the EV kit software
SLS_USB_Driver_Help_200.PDF	USB driver installation help file

Quick Start

Required Equipment

- MAX11043 EV kit
- Windows XP, Windows Vista, or Windows 7 PC with a spare USB port
- Function generator

Note: In the following sections, software-related items are identified by bolding. Text in **bold** refers to items directly from the EV kit software. Text in **bold and underlined** refers to items from the Windows operating system.

Procedure

The EV kit is fully assembled and tested. Follow the steps below to verify board operation:

- 1) Visit www.maxim-ic.com/evkitsoftware to download the latest version of the EV kit software, 11043Rxx.ZIP. Save the EV kit software to a temporary folder and uncompress the ZIP file.
- 2) Install the EV kit software and USB driver on your computer by running the INSTALL.EXE program inside the temporary folder. The program files are copied to your PC and icons are created in the Windows **Start | Programs** menu. During software installation, some versions of Windows may show a warning message indicating that this software

is from an unknown publisher. This is not an error condition and it is safe to proceed with installation. Administrator privileges are required to install the USB device driver on Windows.

- 3) Verify that the jumpers on the EV kit board are in their default positions, as shown in Table 1. The jumper locations are shown in Figure 1.
- 4) Set the signal source to generate a 1kHz, 2.0V peak-to-peak sinusoidal wave with 0V offset.
- 5) Connect the positive terminal of the signal generator to the AINAP terminal block connector. Connect the negative terminal of the signal generator to the AINAN terminal block connector.
- 6) Connect the USB cable from the PC to the EV kit board. Follow the instructions on the SLS_USB_Driver_Help_200.PDF file to manually install the USB driver. Administrator privileges are required to install the USB device driver on Windows.
- 7) Enable the function generator.
- 8) Start the EV kit software by opening its icon in the Windows **All Programs** menu. The EV kit software main window appears, as shown in Figure 2.
- 9) The main window should display **Hardware Connected** on the status bar.
- 10) Check channel **A** in the **Automatic ADC result output** group box.
- 11) Navigate to the **ADC Configuration and Gain** tab shown in Figure 5. In the **ADC_A (0Ch)** group box, set PGA gain to **1**, programmable filter to **LP**, and then press the **Write** button.
- 12) Navigate to the **Data Acquisition** tab (Figure 4). Click on the **Number of Samples Requested** drop-down list and select **8192**.
- 13) Press the **Start Conversion** button.
- 14) Verify that the waveform displayed in the GUI FFT graph is approximately 1000Hz, as shown in Figure 3.

MAX11043ATL Evaluation Kit

Evaluates: MAX11043

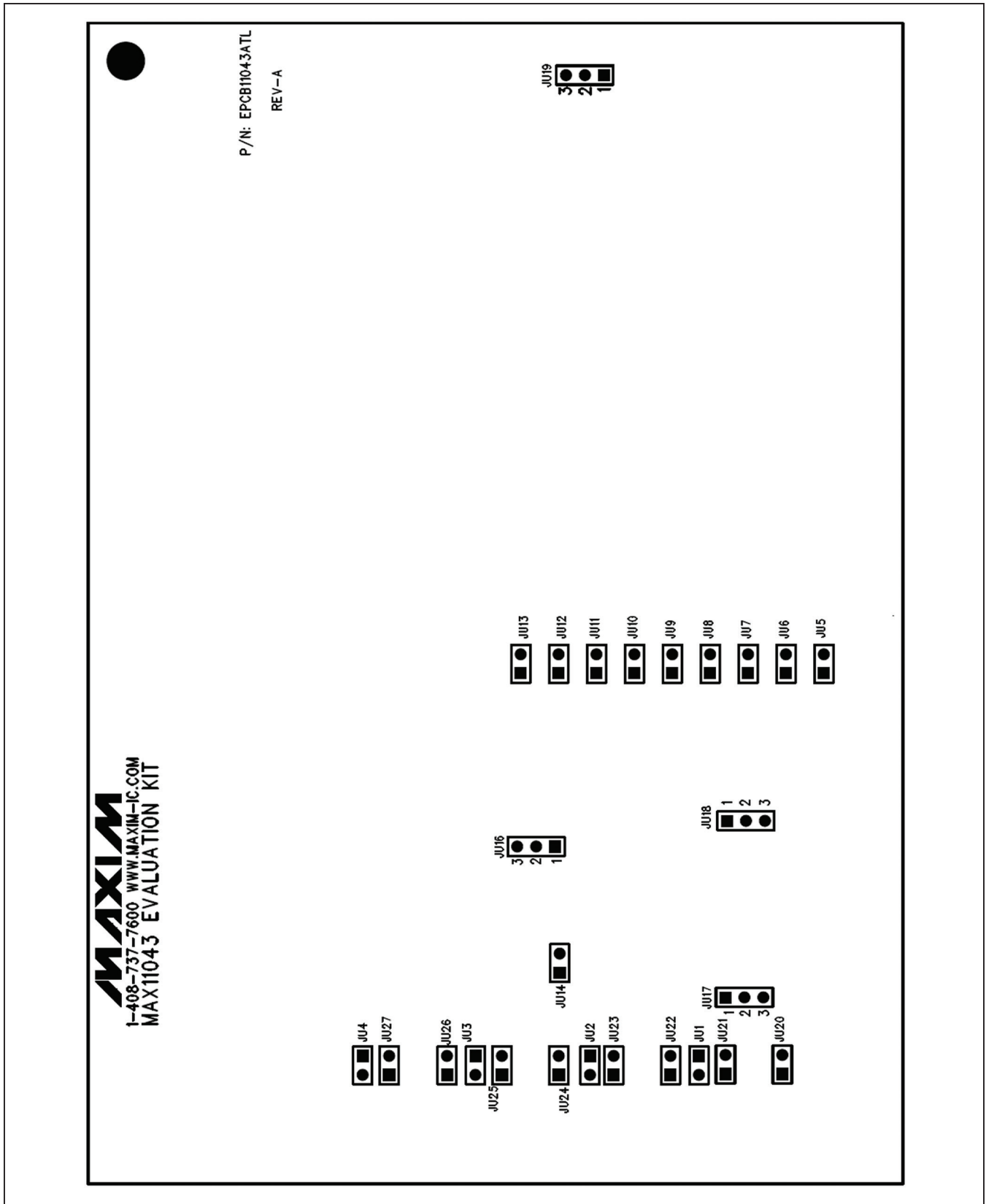

Figure 1. MAX11043 EV Kit Jumper Locations

MAX11043ATL Evaluation Kit

Evaluates: MAX11043

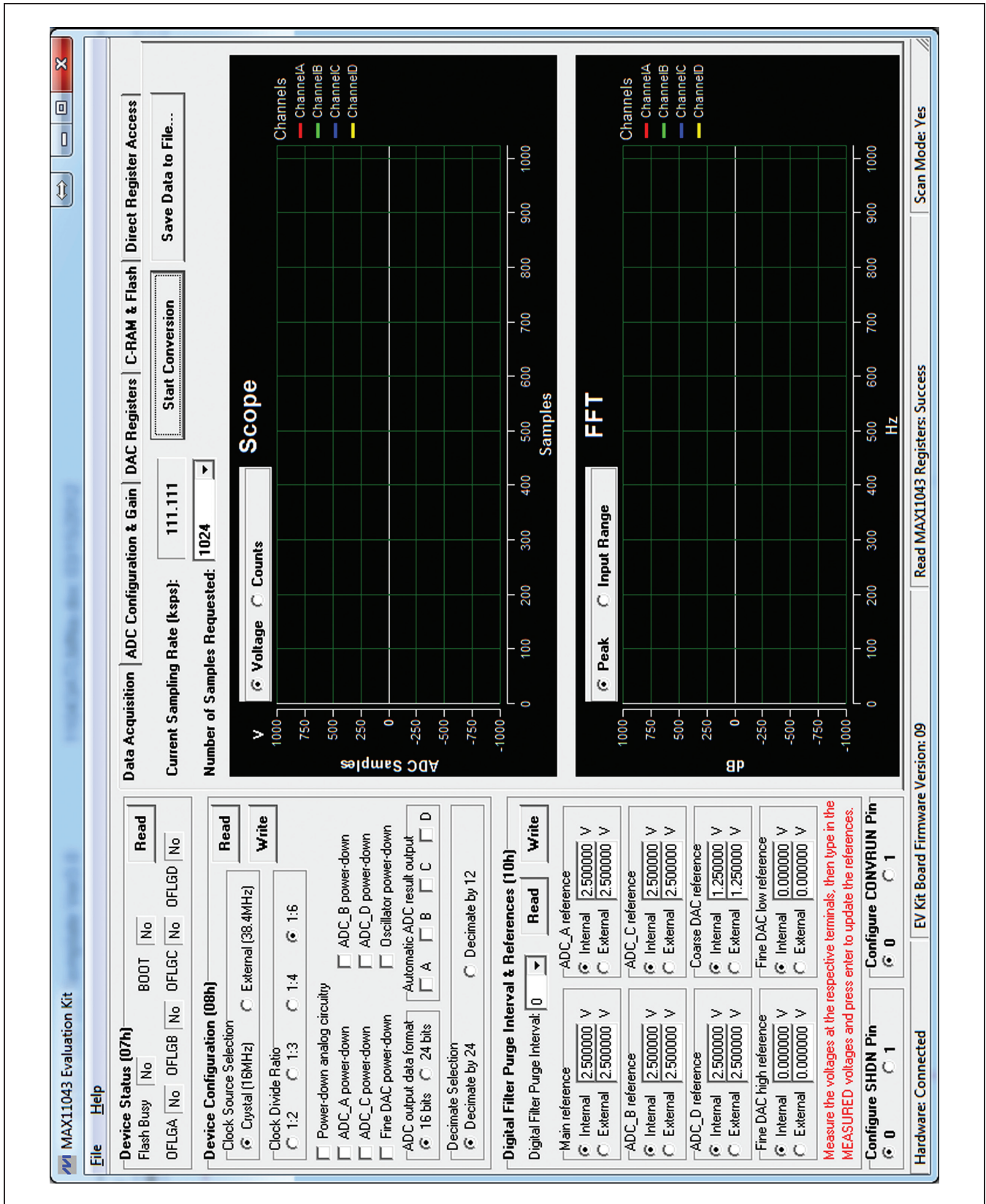

Figure 2. MAX11043 EV Kit Software (Main Window)

MAX11043ATL Evaluation Kit

Evaluates: MAX11043

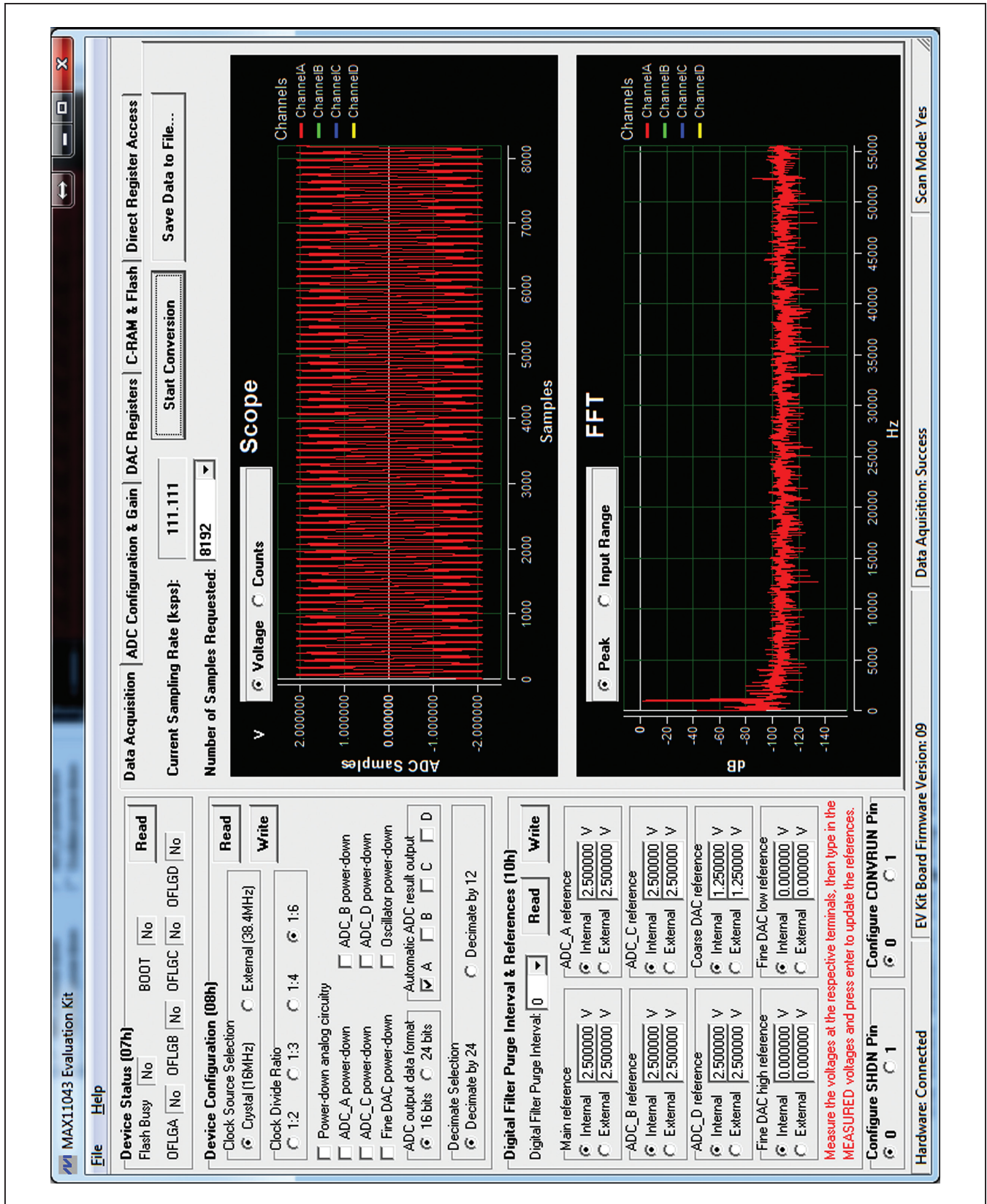

Figure 3. MAX11043 EV Kit Software (Quick Start Data Sampling Graph)

MAX11043ATL Evaluation Kit

Evaluates: MAX11043

Detailed Description of Software

The main window of the evaluation software (Figure 2) displays the MAX11043 device status register, device configuration register, digital filter purge interval and reference register, and five tab sheets.

Device Status (07h) Group Box

Press the **Read** button in this group box to read the status of the IC.

Device Configuration (08h) Group Box

This group box displays the configuration register. Press the **Read** button in the group box to read the register. To write new values to the register, first select the desired configuration, and then press the **Write** button.

Digital Filter Purge Interval & References (10h) Group Box

This group box displays the digital purge interval and reference configuration register. Press the **Read** button in the group box to read the register. To write new values to the register, first select the desired configuration, and then press the **Write** button.

If internal references are used, the user should measure the real reference values and type in the measured values in the respective edit box and press Enter to update the reference values. Otherwise, the nominal values are used.

If external references are used, apply the external references on the respective terminal block connectors.

Configure SHDN Pin and Configure CONVRUN Pin Group Boxes

These two group boxes are used to set or clear the SHDN or CONVRUN pins on the IC.

Data Acquisition Tab

On the **Data Acquisition** tab sheet (Figure 4), the user can select the desired number of conversions in the **Number of Samples Requested** drop-down list. The sampling

rate is also displayed. Press the **Start Conversion** button to start sampling. After sampling is finished, the user can save the data to a file by pressing the **Save Data to File...** button.

After the **Start Conversion** button is pressed, the sampled data in the time domain is plotted in the **Scope** window. The user can select the scope window in either counts or in calculated voltages. The sampled data in the frequency domain is plotted in the **FFT** window. The user can select the FFT calculation based on the maximum ADC resolution (16-bit or 24-bit) by clicking on the **Peak** radio button, or the FFT calculation based on maximum input value by clicking on the **Input Range** radio button.

ADC Configuration and Gain Tab

On the **ADC Configuration and Gain** tab sheet, all ADC configuration registers and fine gain registers are displayed, as shown in Figure 5.

DAC Registers Tab

On the **DAC Registers** tab sheet, the fine DAC register, the DAC step register, and the coarse DAC registers are displayed, as shown in Figure 6.

The UP/\overline{DWN} and DACSTEP pin functions are also provided.

C-RAM and Flash Tab

As shown in Figure 7, this tab sheet provides the functions of C-RAM and flash operations.

Important Note: Save the content of the flash to a file in case they are needed later.

Direct Register Access Tab

The controls on this tab sheet (Figure 8) are provided for low-level device debugging purposes. The user can manually send read and write commands to each register on the IC.

MAX11043ATL Evaluation Kit

Evaluates: MAX11043

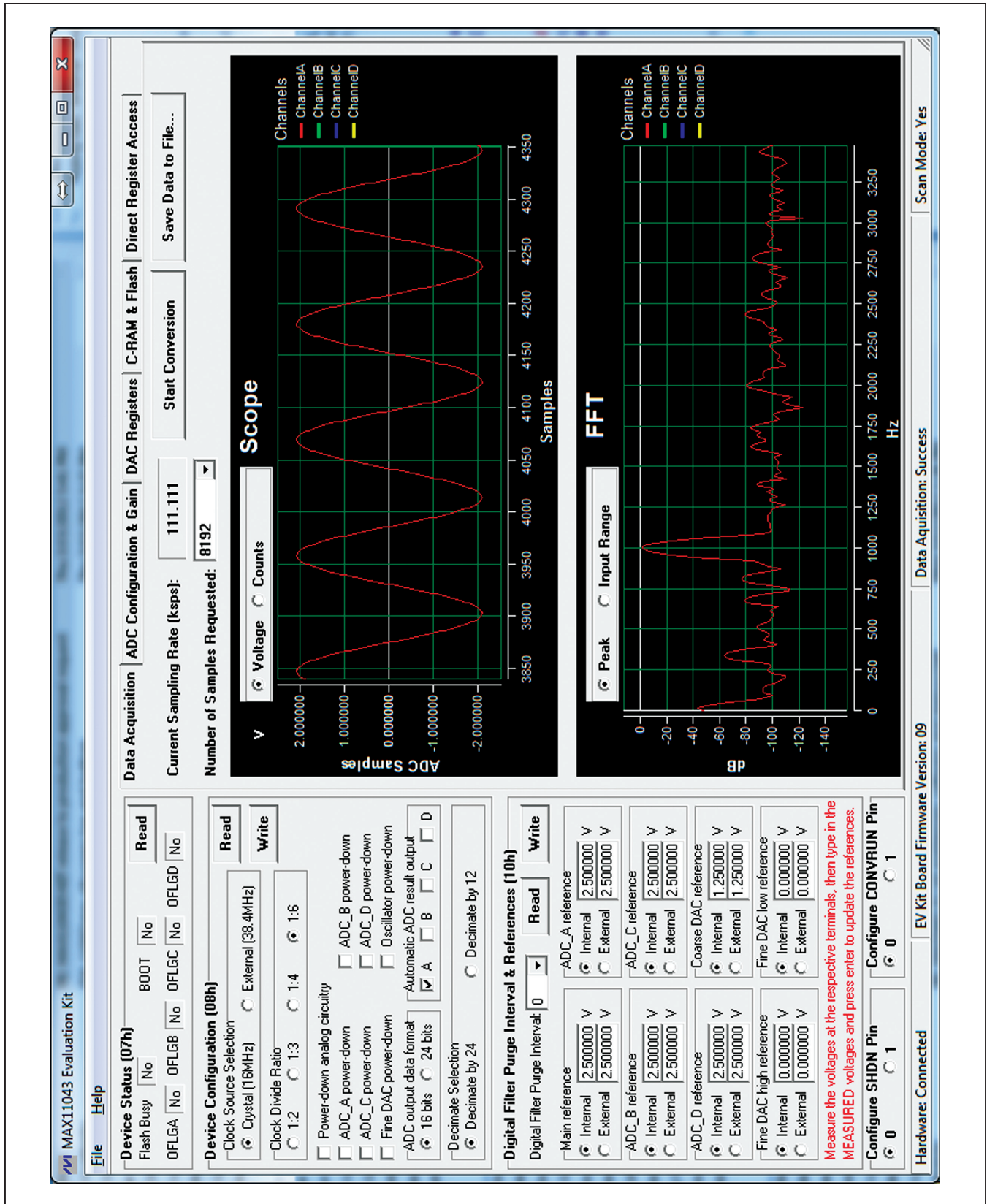

Figure 4. MAX11043 EV Kit Software Main Window (Data Acquisition Tab)

MAX11043ATL Evaluation Kit

Evaluates: MAX11043

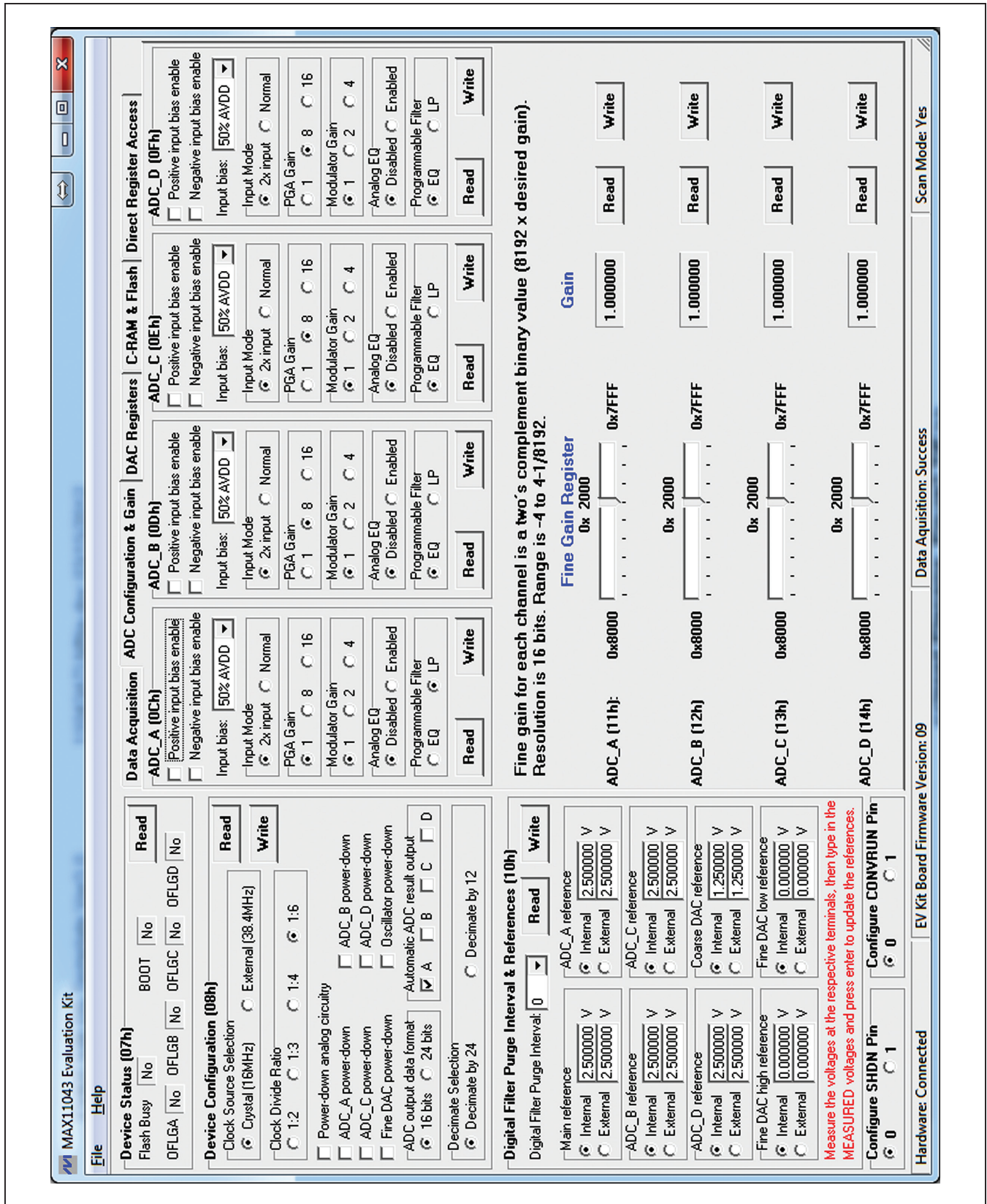

Figure 5. MAX11043 EV Kit Software Main Window (ADC Configuration & Gain Tab)

MAX11043ATL Evaluation Kit

Evaluates: MAX11043

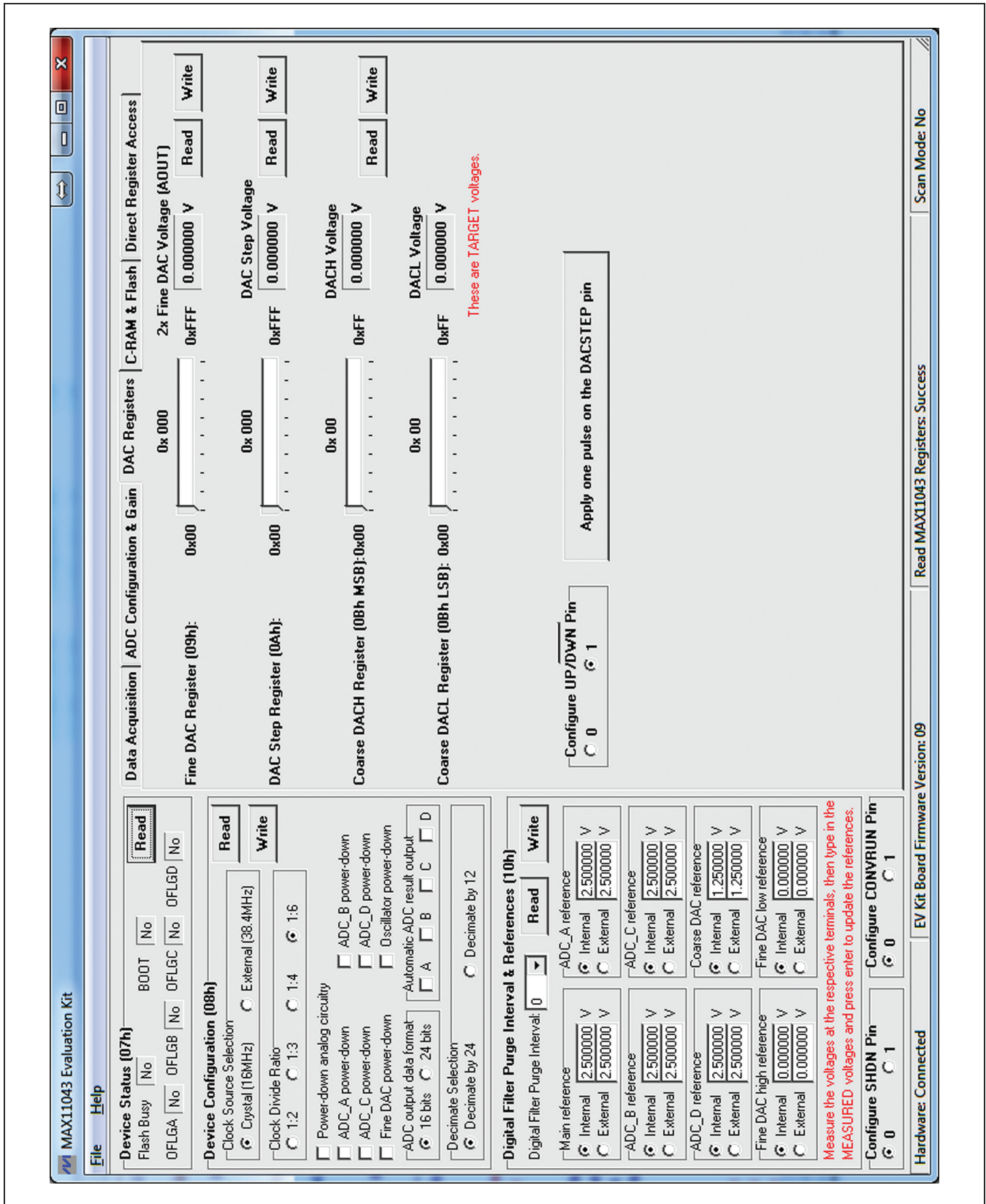

Figure 6. MAX11043 EV Kit Software Main Window (DAC Registers Tab)

MAX11043ATL Evaluation Kit

Evaluates: MAX11043

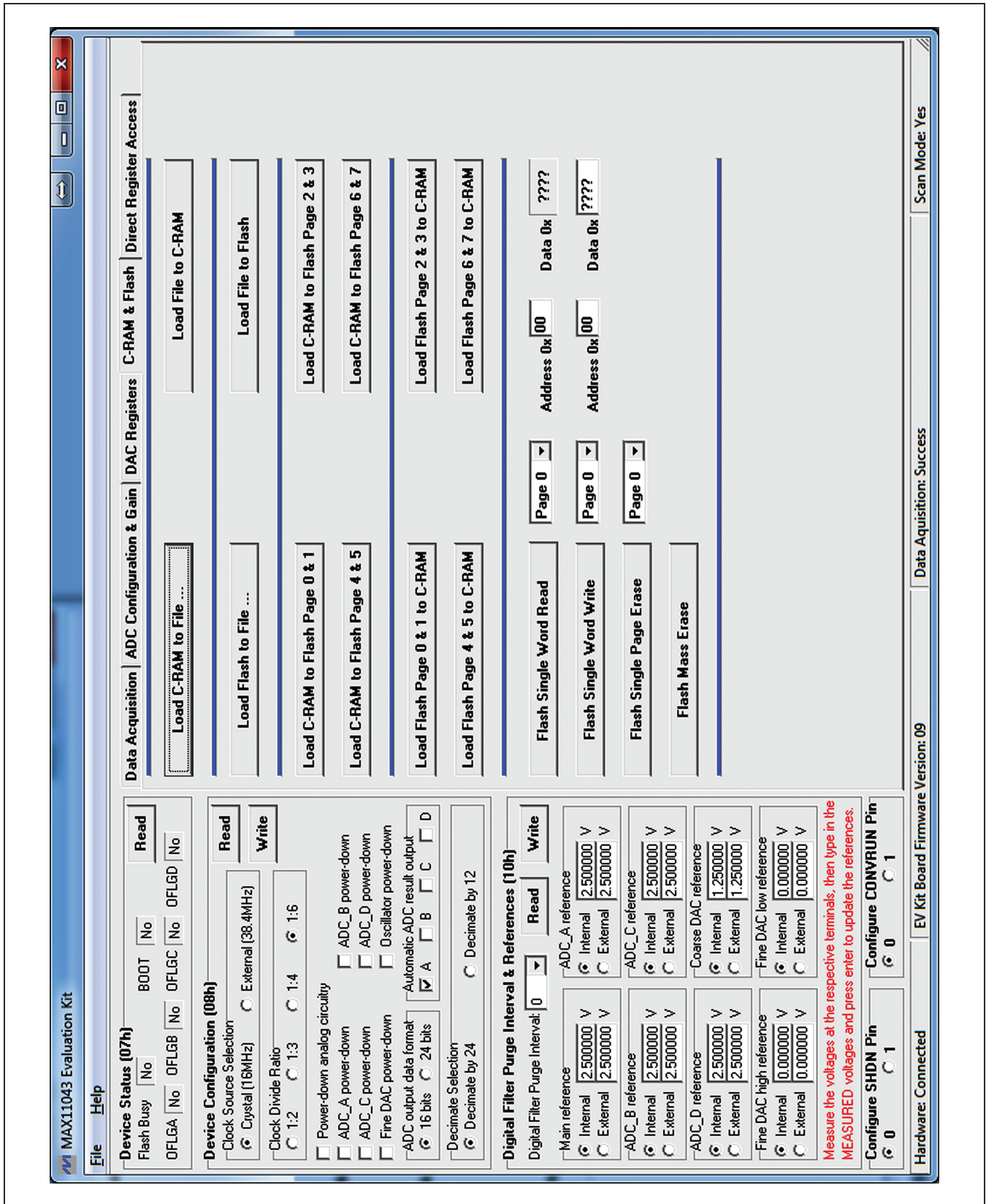

Figure 7. MAX11043 EV Kit Software Main Window (C-RAM & Flash Tab)

MAX11043ATL Evaluation Kit

Evaluates: MAX11043

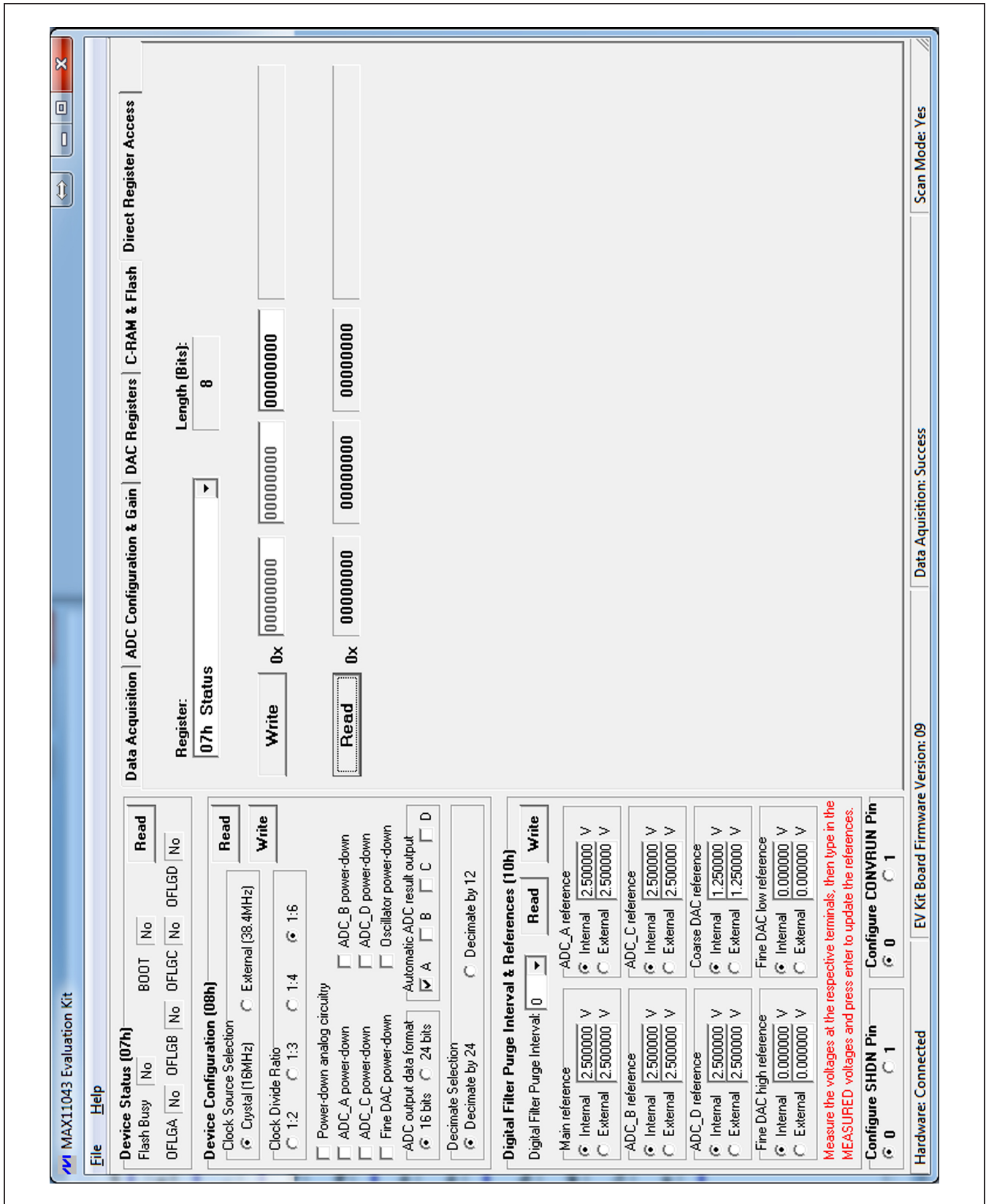

Figure 8. MAX11043 EV Kit Software Main Window (Direct Register Access Tab)

MAX11043ATL Evaluation Kit

Evaluates: MAX11043

Detailed Description of Hardware

The MAX11043ATL EV kit is a fully assembled and tested PCB that evaluates the MAX11043 4-channel, 16-bit, simultaneous-sampling ADCs with PGA, filter, and an 8-/12-bit dual-stage DAC.

The EV kit is installed with a MAX11043ATL+ in a 40-pin TQFN package with an exposed pad. An on-board +2.5V voltage reference (MAX6126) is provided. Contact Maxim for other high-precision voltage references if reference voltages other than +2.5V are required.

User-Supplied SPI Interface and GPIO Controls

For a user-supplied control interface, first remove the shunts on jumpers JU5–JU13 and connect the user-supplied control signals to the corresponding SHDN, EOC, SCLK, DIN, DOUT, CS, CONVRUN, DACSTEP, UP/DWN test points on the EV kit.

Table 1. Jumper Descriptions (JU1–JU14, JU16–JU27)

JUMPER	SHUNT POSITION	DESCRIPTION
JU1	1-2	Channel A is configured for single-ended input operation.
	Pin 1*	Channel A is configured for differential input operation.
JU2	1-2	Channel B is configured for single-ended input operation.
	Pin 1*	Channel B is configured for differential input operation.
JU3	1-2	Channel C is configured for single-ended input operation.
	Pin 1*	Channel C is configured for differential input operation.
JU4	1-2	Channel D is configured for single-ended input operation.
	Pin 1*	Channel D is configured for differential input operation.
JU5	1-2*	Use the on-board UP/DOWN control.
	Pin 1	Use the user-supplied UP/DOWN control.
JU6	1-2*	Use the on-board DACSTEP control.
	Pin 1	Use the user-supplied DACSTEP control.
JU7	1-2*	Use the on-board CONVRUN control.
	Pin 1	Use the user-supplied CONVRUN control.
JU8	1-2*	Use the on-board CS control.
	Pin 1	Use the user-supplied CS control.
JU9	1-2*	Use the on-board DOUT control.
	Pin 1	Use the user-supplied DOUT control.
JU10	1-2*	Use the on-board DIN control.
	Pin 1	Use the user-supplied DIN control.
JU11	1-2*	Use the on-board SCLK control.
	Pin 1	Use the user-supplied SCLK control.
JU12	1-2*	Use the on-board EOC control.
	Pin 1	Use the user-supplied EOC control.
JU13	1-2*	Use the on-board SHDN control.
	Pin 1	Use the user-supplied SHDN control.
JU14	1-2	Use the on-board 2.5V as REFBP.
	Pin 1*	Use the internal REFBP.
JU16	1-2	FPGA generated 38.4MHz clock connected to the OSCIN pin.
	2-3*	On-board 16MHz crystal connected to the OSCIN pin.
JU17	1-2*	AVDD is connected to the on-board 3.3V DC.
	2-3	AVDD is connected to the user-supplied power supply.
JU18	1-2*	DVDD is connected to the on-board 3.3V DC.
	2-3	DVDD is connected to the user-supplied power supply.

MAX11043ATL Evaluation Kit

Evaluates: MAX11043

Table 1. Jumper Descriptions (JU1–JU14, JU16–JU27) (continued)

JUMPER	SHUNT POSITION	DESCRIPTION
JU19	1-2*	The board is powered by the USB.
	2-3	The board is powered by the user-supplied 5V DC.
JU20	1-2	AINAP connected to the signal source directly.
	Pin 1*	AINAP coupled to the signal source through a 10μF capacitor.
JU21	1-2	AINAN connected to the signal source directly.
	Pin 1*	AINAN coupled to the signal source through a 10μF capacitor.
JU22	1-2	AINBP connected to the signal source directly.
	Pin 1*	AINBP coupled to the signal source through a 10μF capacitor.
JU23	1-2	AINBN connected to the signal source directly.
	Pin 1*	AINBN coupled to the signal source through a 10μF capacitor.
JU24	1-2	AINCP connected to the signal source directly.
	Pin 1*	AINCP coupled to the signal source through a 10μF capacitor.
JU25	1-2	AINCN connected to the signal source directly.
	Pin 1*	AINCN coupled to the signal source through a 10μF capacitor.
JU26	1-2	AINDP connected to the signal source directly.
	Pin 1*	AINDP coupled to the signal source through a 10μF capacitor.
JU27	1-2	AINDN connected to the signal source directly.
	Pin 1*	AINDN coupled to the signal source through a 10μF capacitor.

*Default position.

MAX11043ATL Evaluation Kit

Evaluates: MAX11043

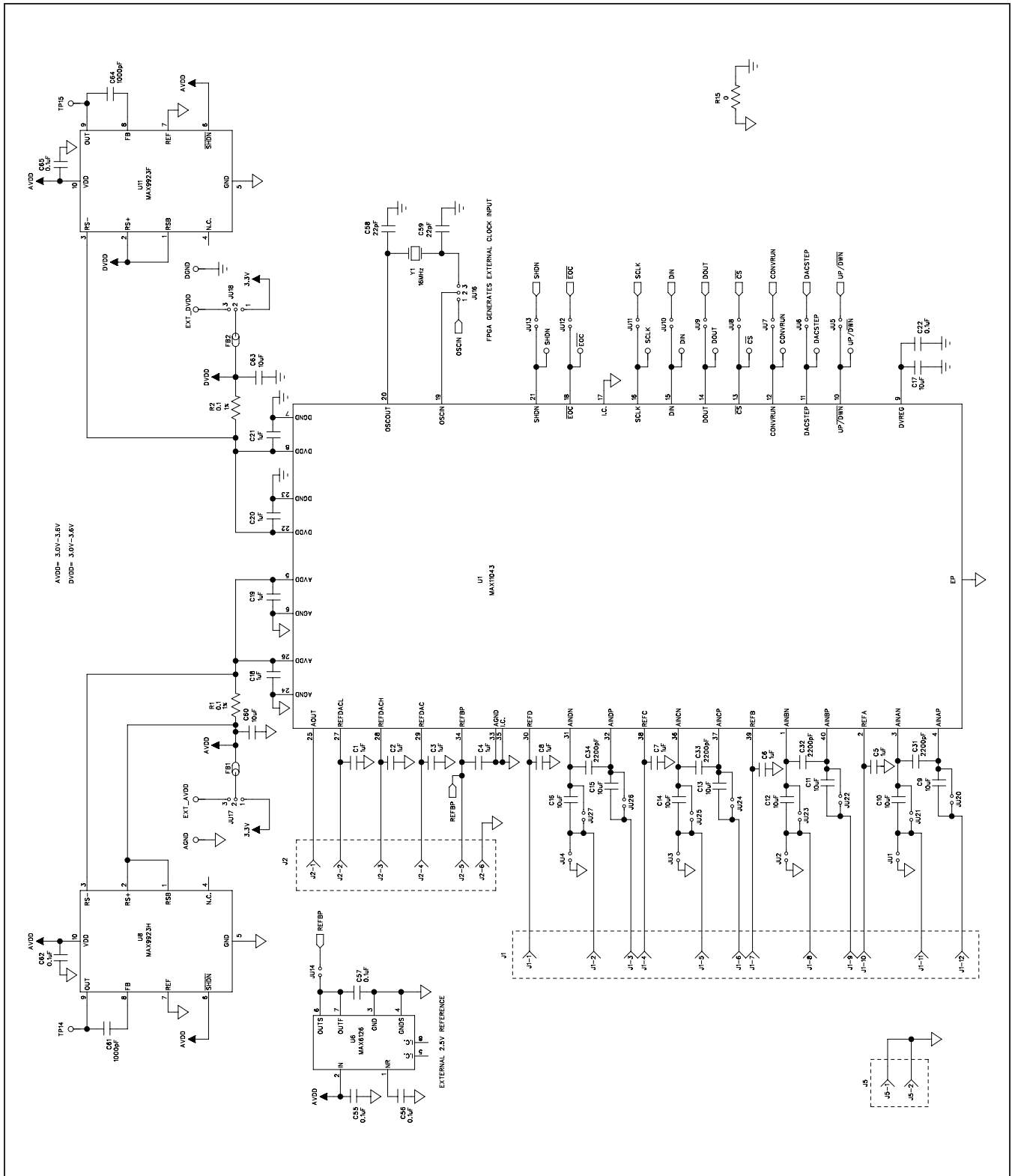

Figure 9a. MAX11043 EV Kit Schematic (Sheet 1 of 10)

MAX11043ATL Evaluation Kit

Evaluates: MAX11043

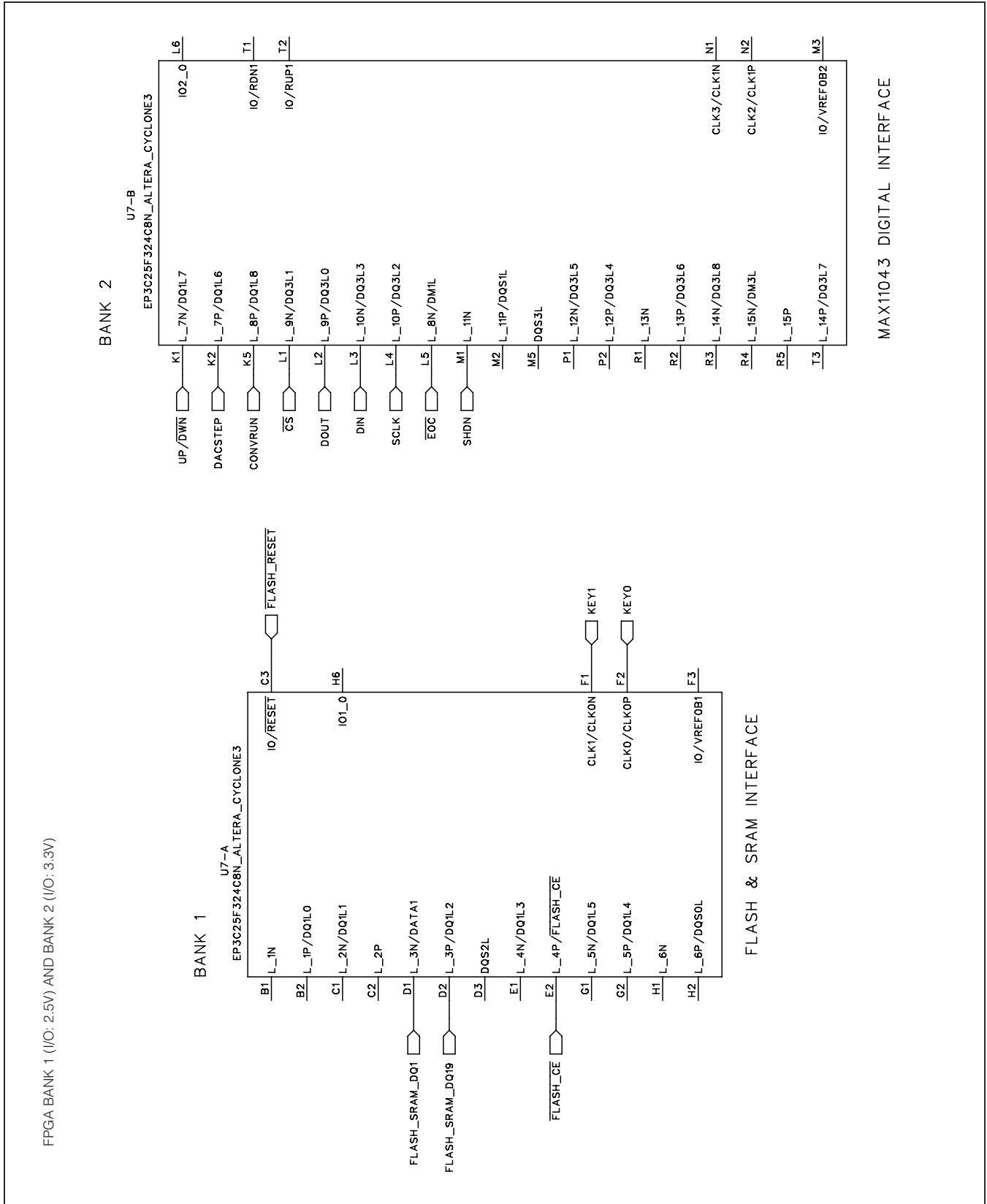

Figure 9b. MAX11043 EV Kit Schematic (Sheet 2 of 10)

MAX11043ATL Evaluation Kit

Evaluates: MAX11043

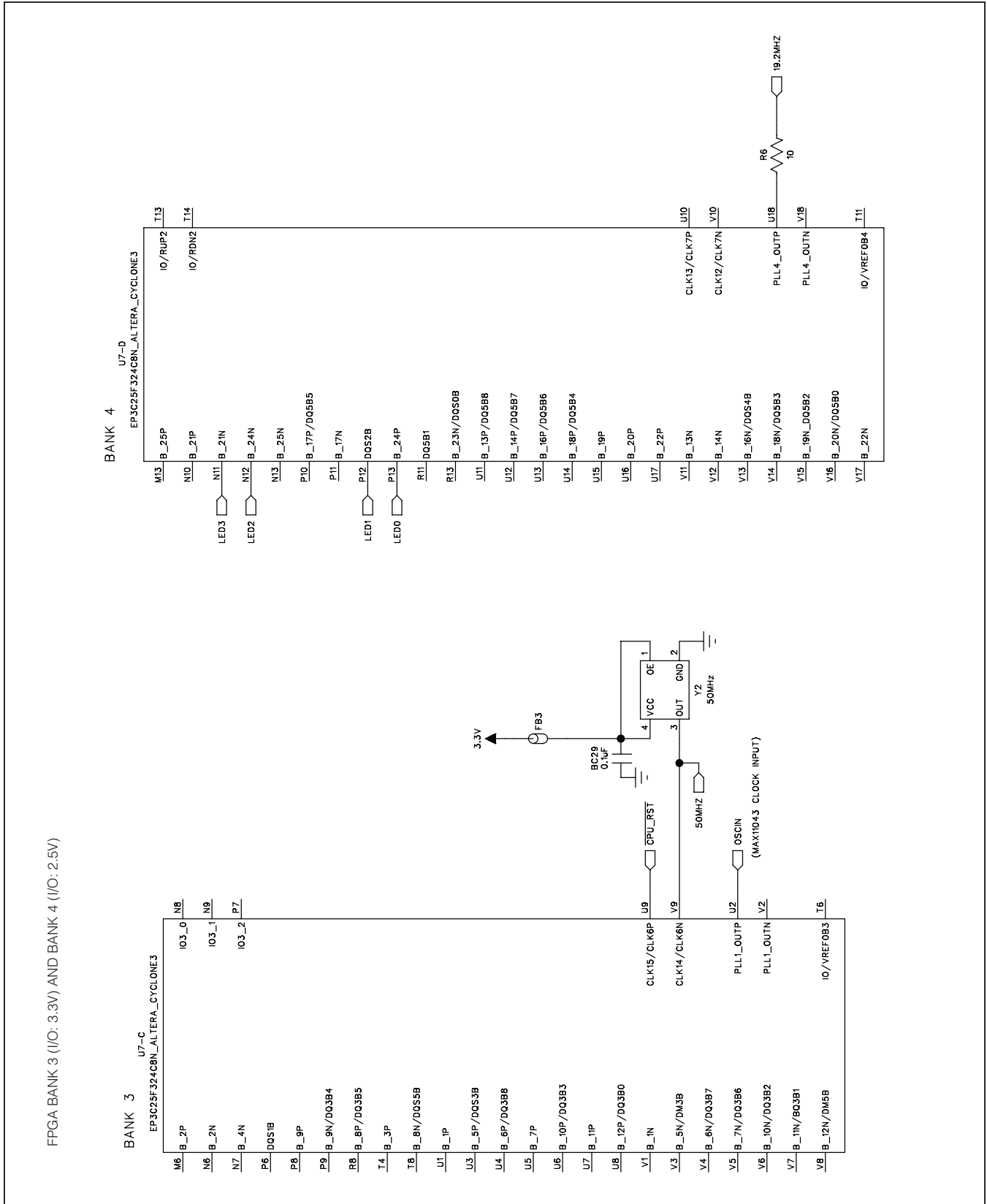

Figure 9c. MAX11043 EV Kit Schematic (Sheet 3 of 10)

MAX11043ATL Evaluation Kit

Evaluates: MAX11043

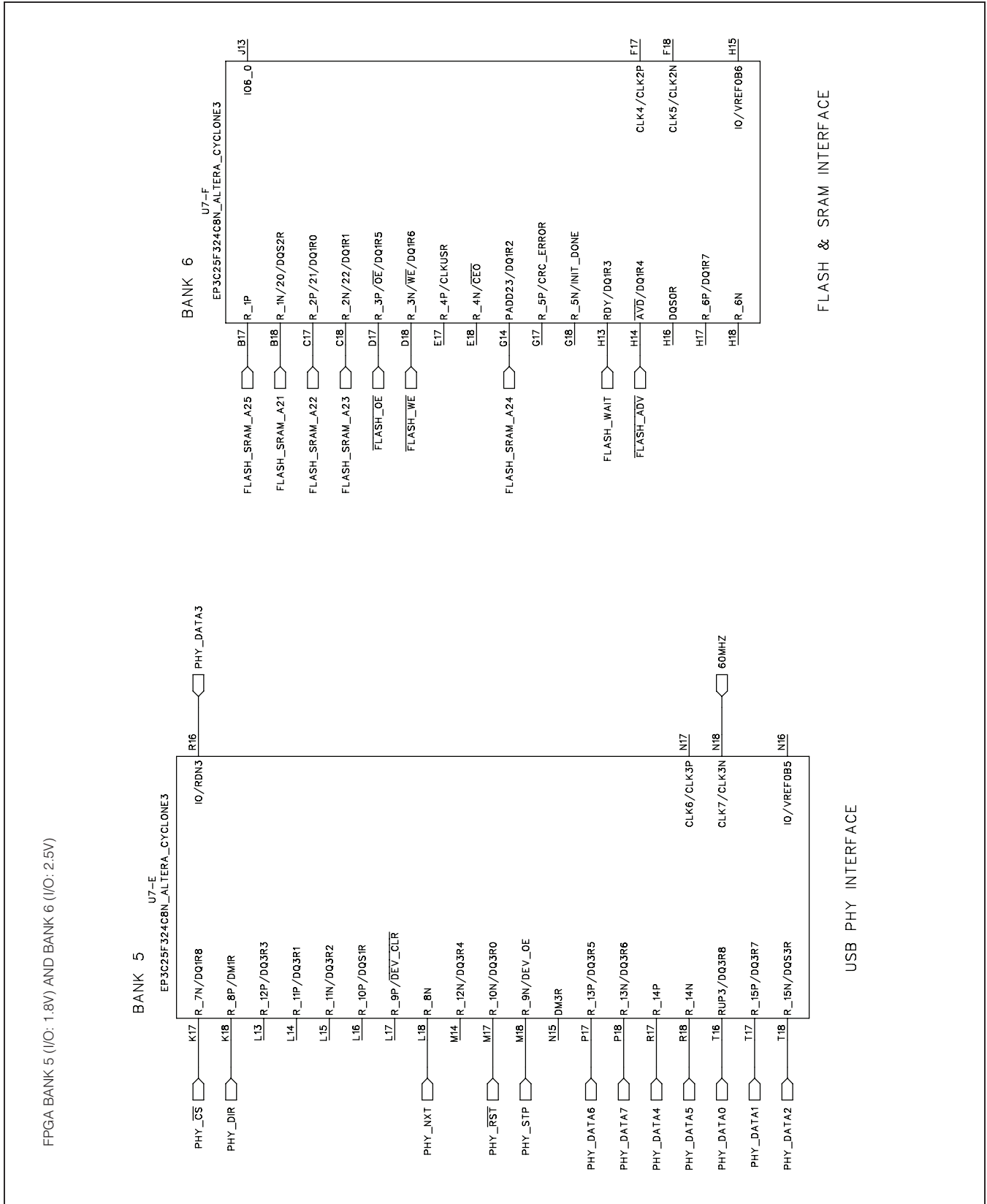

Figure 9d. MAX11043 EV Kit Schematic (Sheet 4 of 10)

MAX11043ATL Evaluation Kit

Evaluates: MAX11043

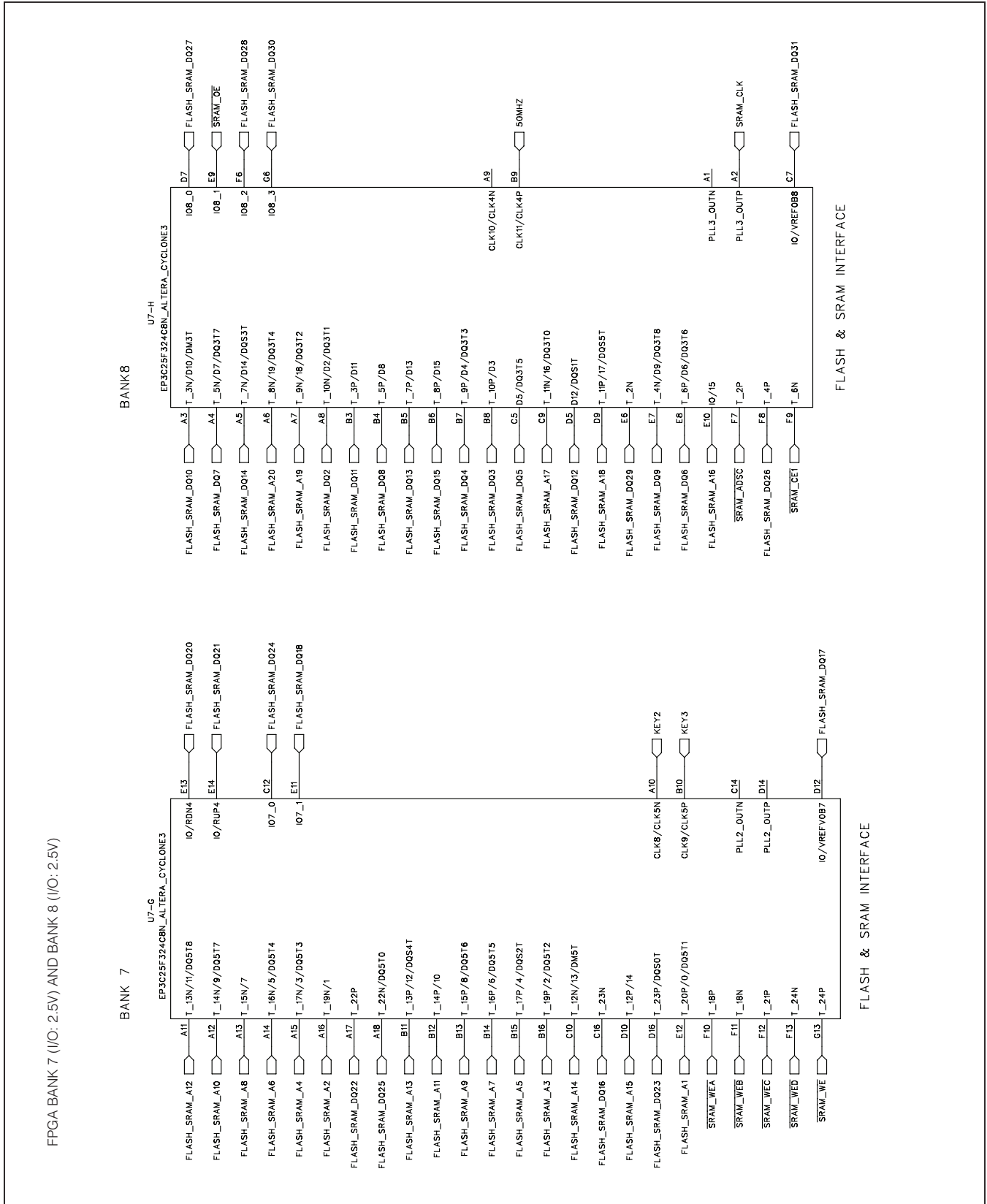

Figure 9e. MAX11043 EV Kit Schematic (Sheet 5 of 10)

MAX11043ATL Evaluation Kit

Evaluates: MAX11043

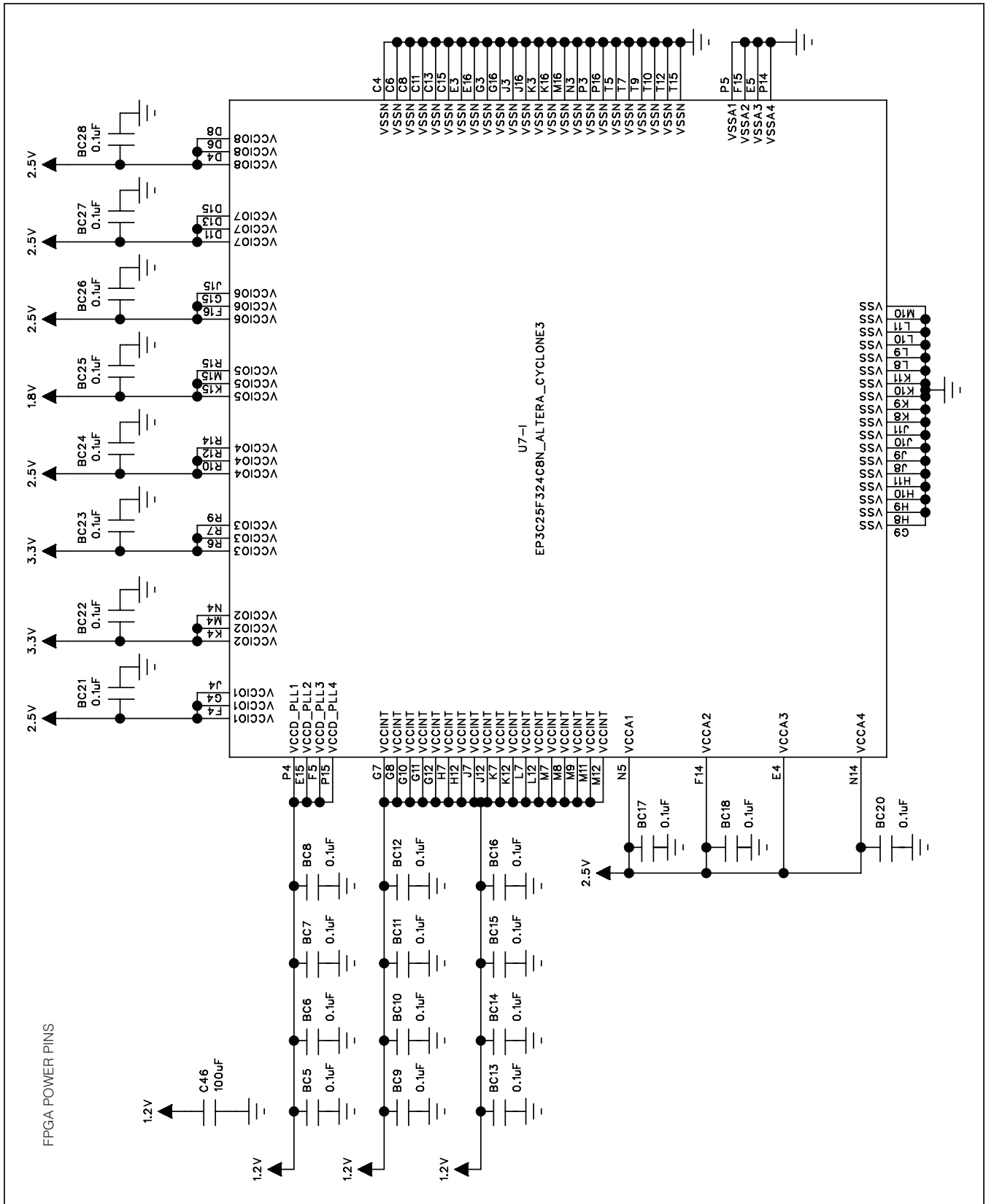

Figure 9f. MAX11043 EV Kit Schematic (Sheet 6 of 10)

MAX11043ATL Evaluation Kit

Evaluates: MAX11043

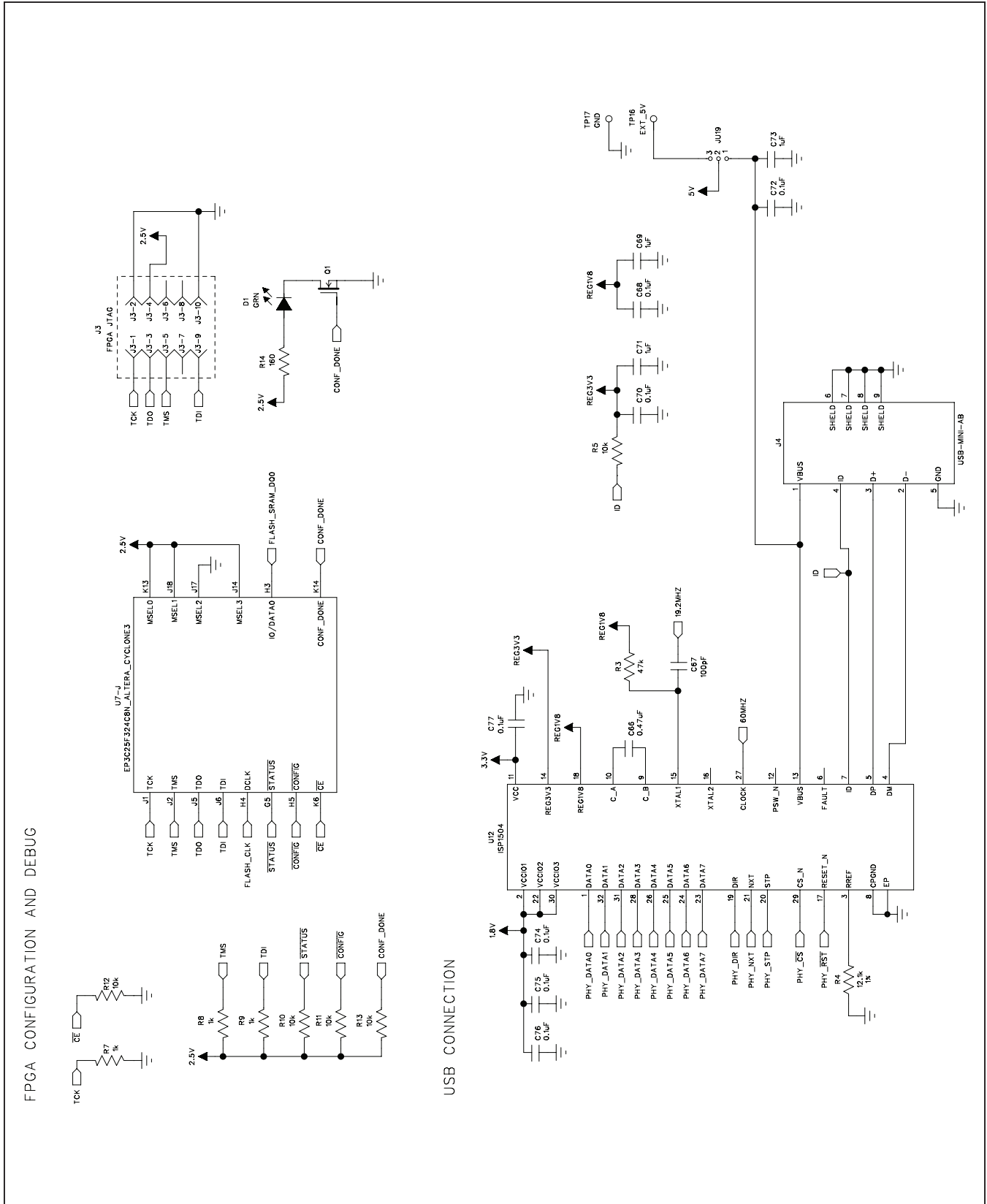
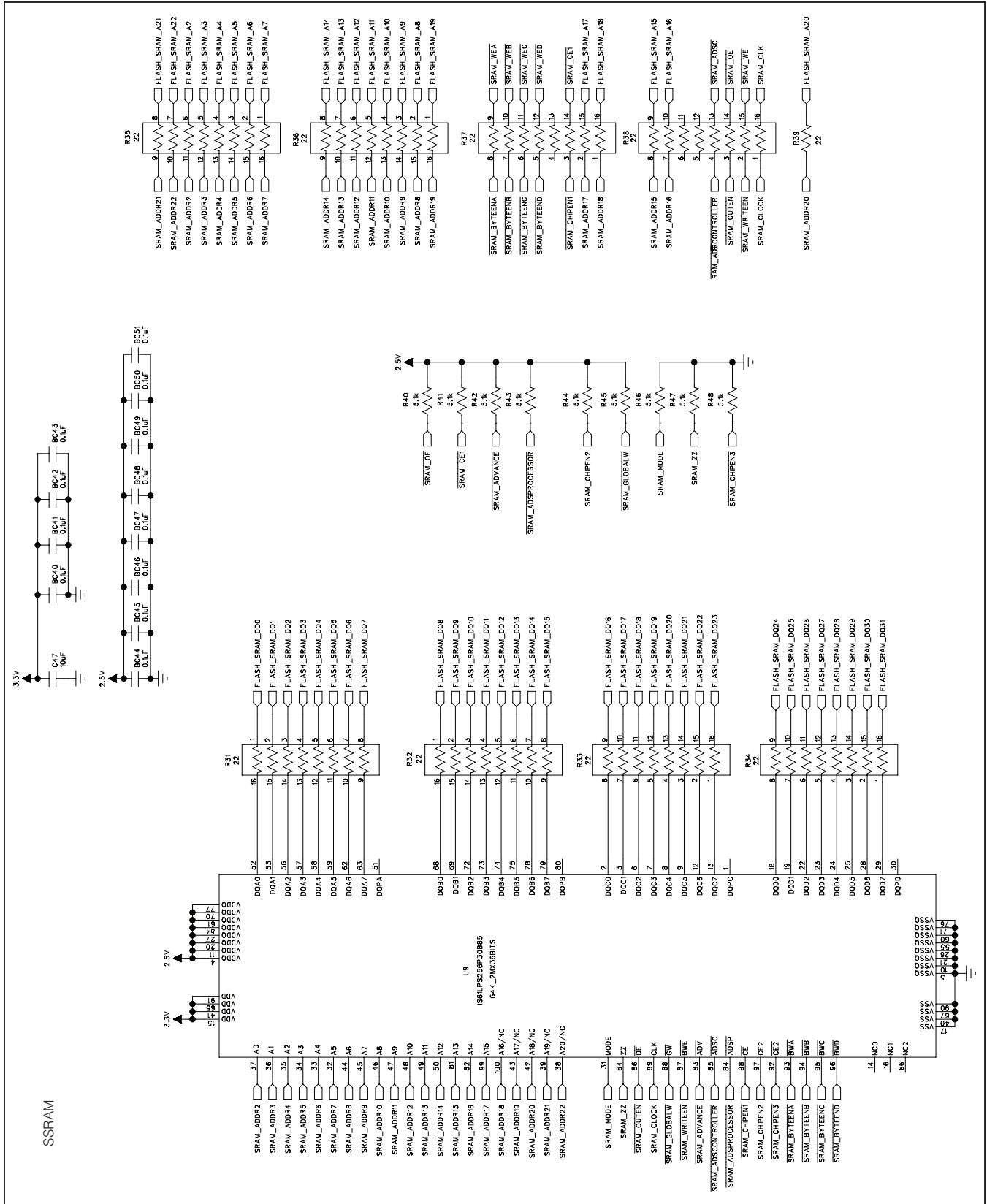

Figure 9g. MAX11043 EV Kit Schematic (Sheet 7 of 10)

MAX11043ATL Evaluation Kit

Evaluates: MAX11043



MAX11043ATL Evaluation Kit

Evaluates: MAX11043

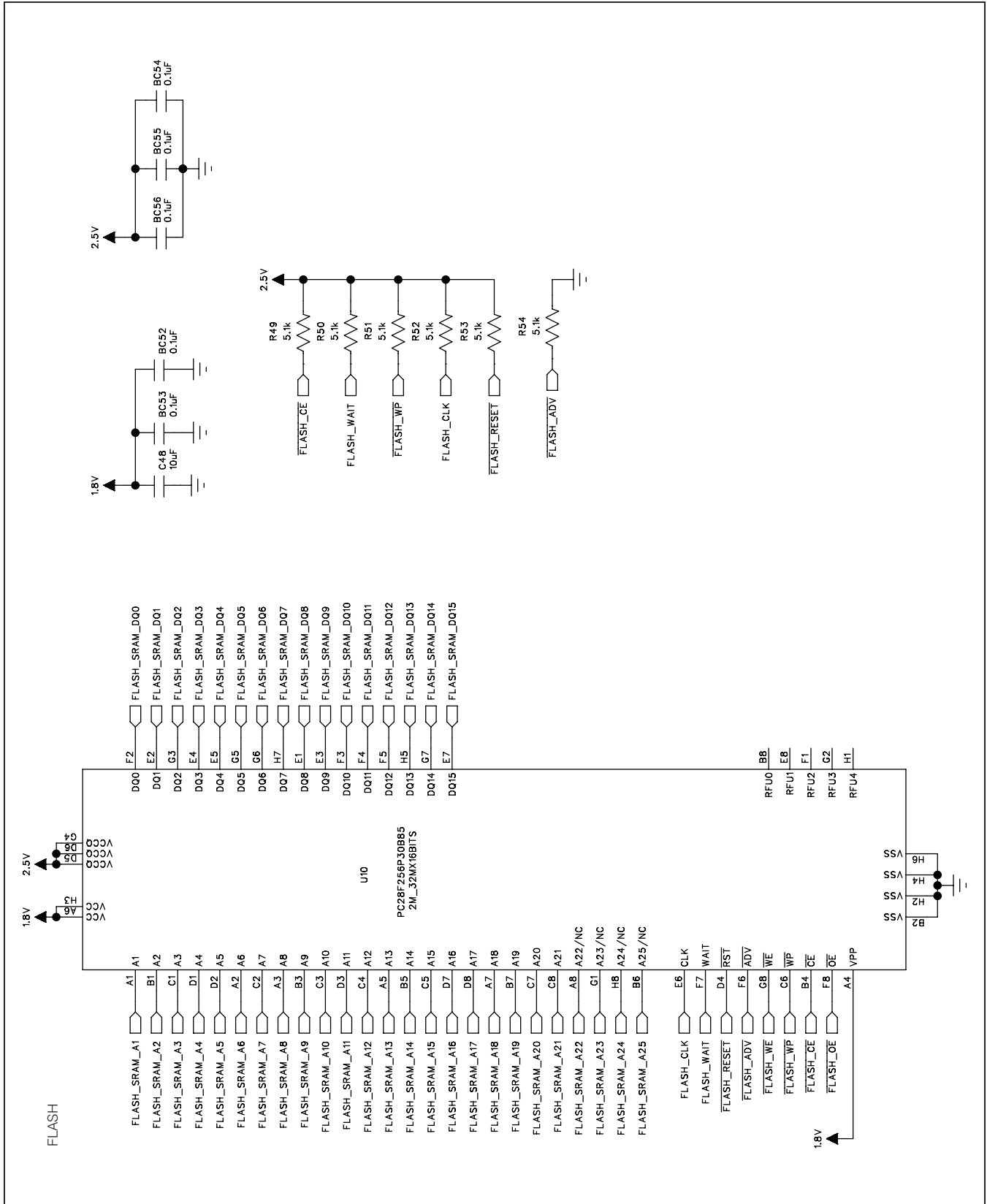

Figure 9i. MAX11043 EV Kit Schematic (Sheet 9 of 10)

MAX11043ATL Evaluation Kit

Evaluates: MAX11043

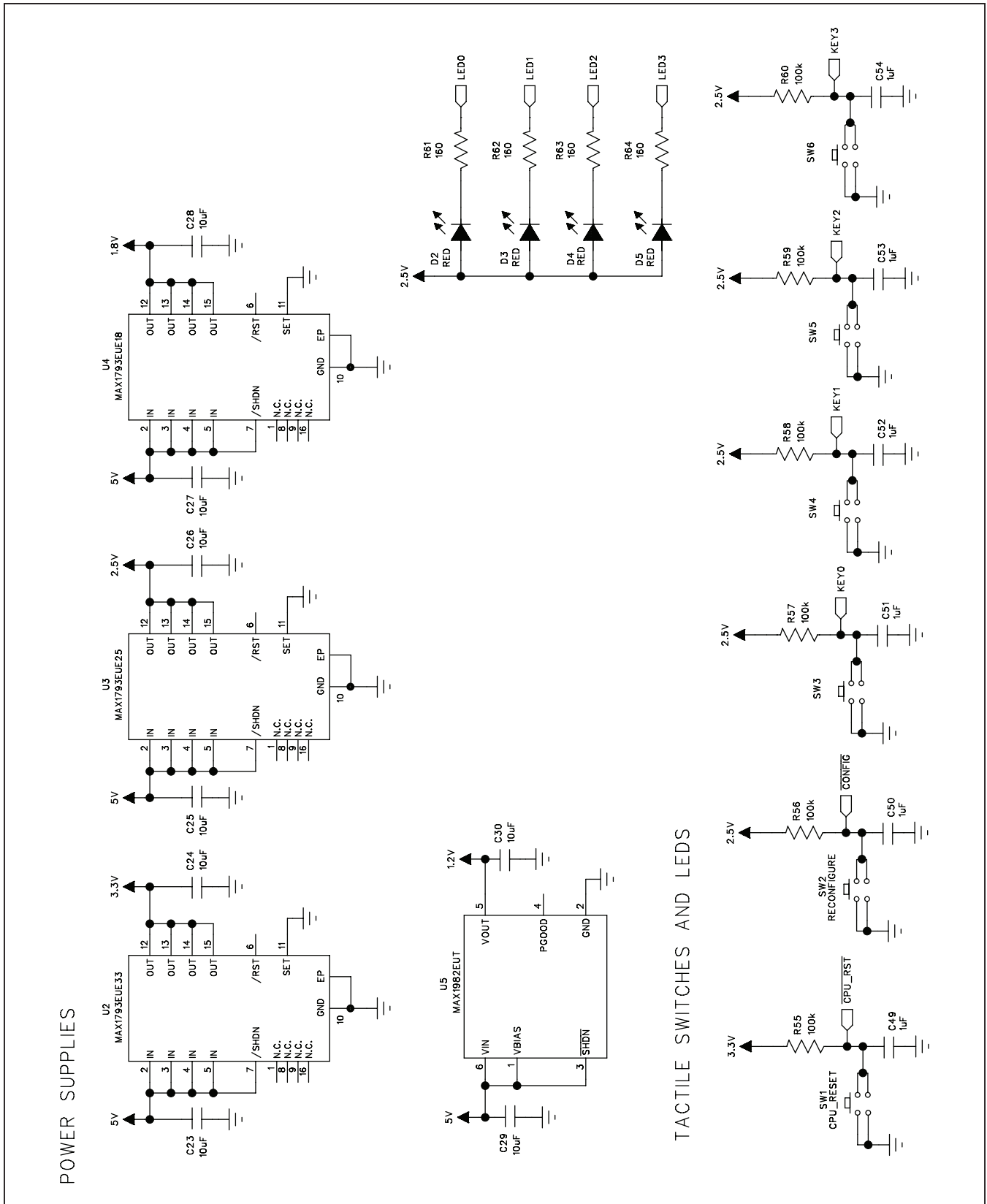

Figure 9j. MAX11043 EV Kit Schematic (Sheet 10 of 10)

MAX11043ATL Evaluation Kit

Evaluates: MAX11043

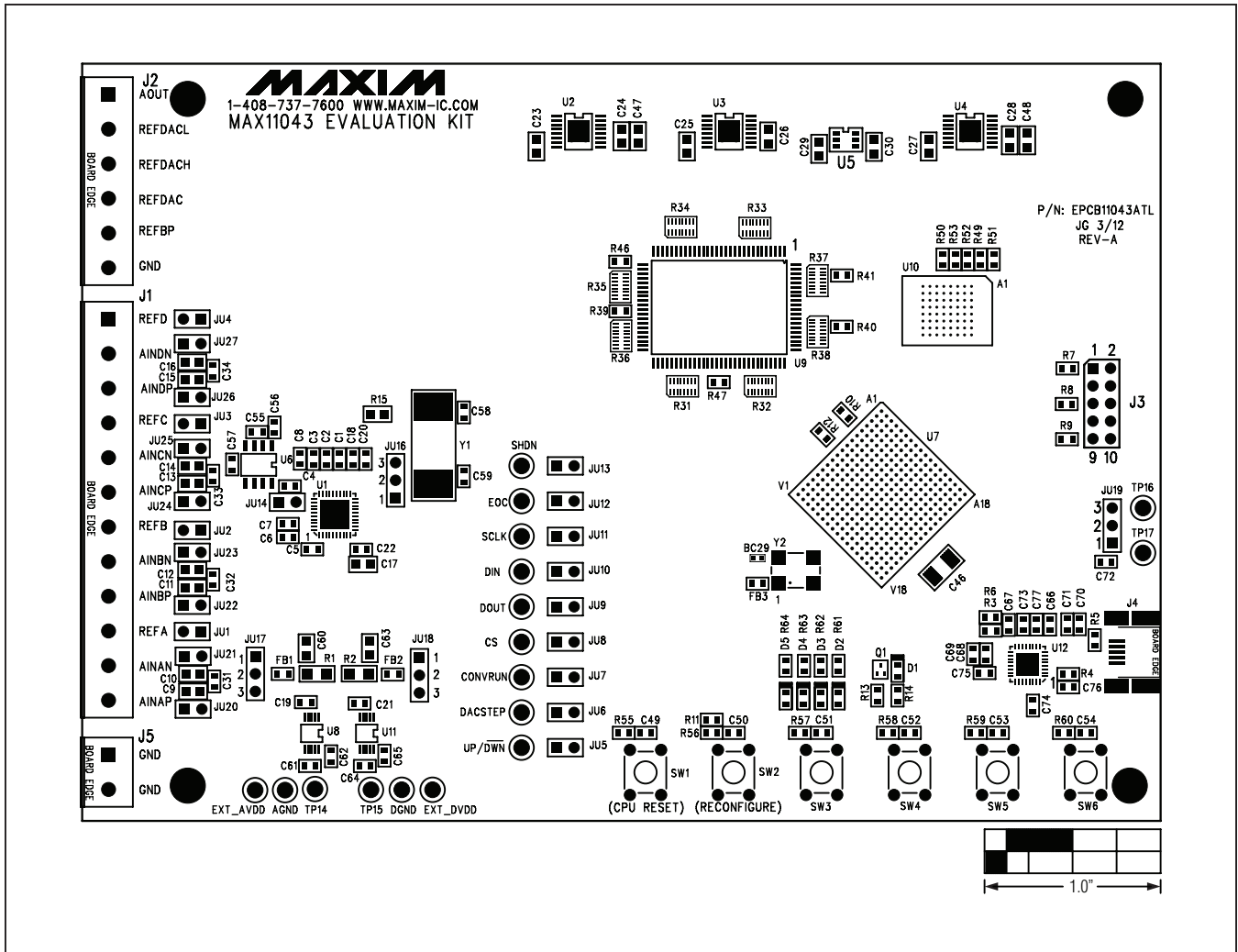

Figure 10. MAX11043 EV Kit Component Placement Guide—Component Side

MAX11043ATL Evaluation Kit

Evaluates: MAX11043

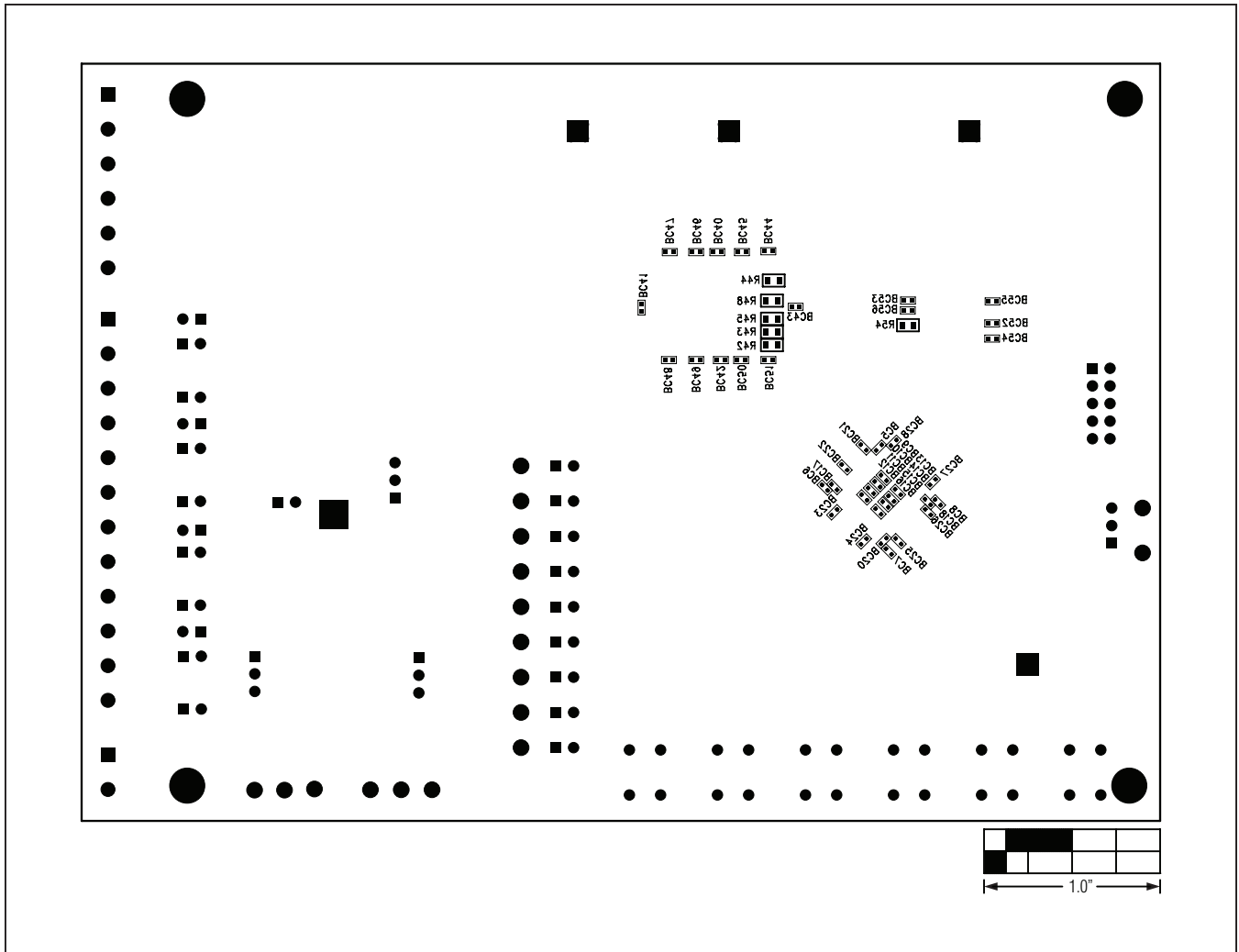

Figure 11. MAX11043 EV Kit Component Placement Guide—Solder Side

MAX11043ATL Evaluation Kit

Evaluates: MAX11043

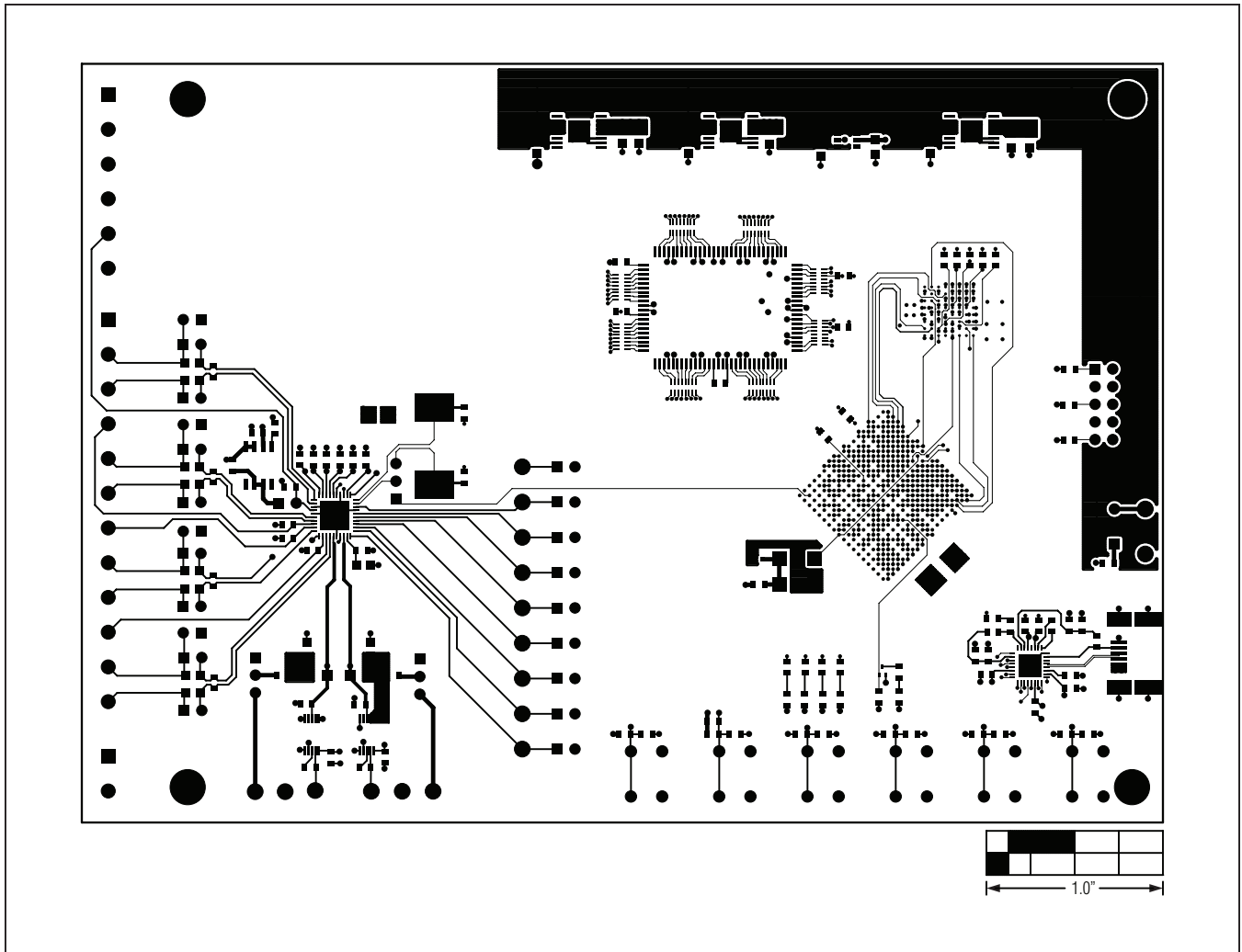

Figure 12. MAX1104311043 EV Kit PCB Layout—Component Side

MAX11043ATL Evaluation Kit

Evaluates: MAX11043

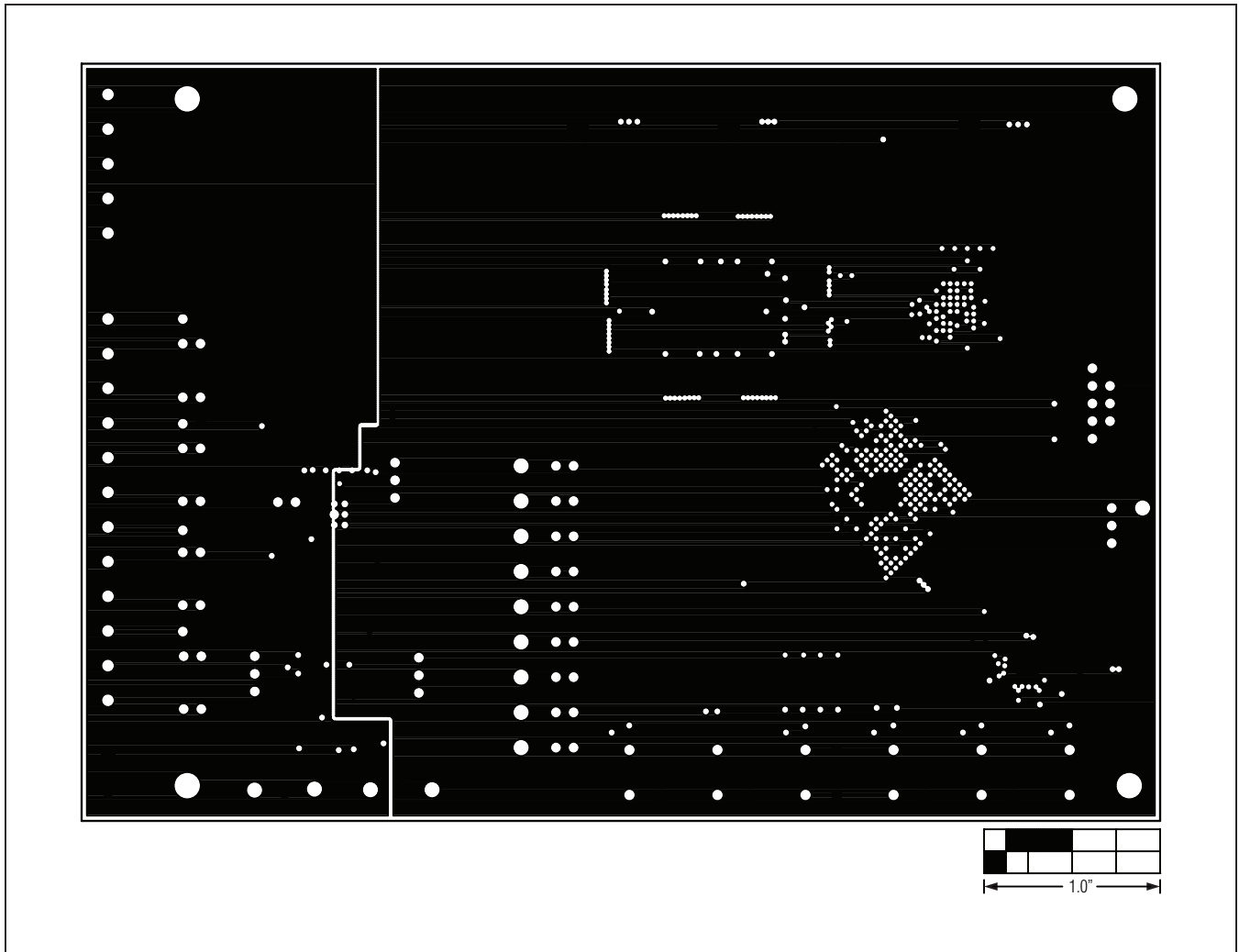

Figure 13. MAX11043 EV Kit PCB Layout—Ground Layer 2

MAX11043ATL Evaluation Kit

Evaluates: MAX11043

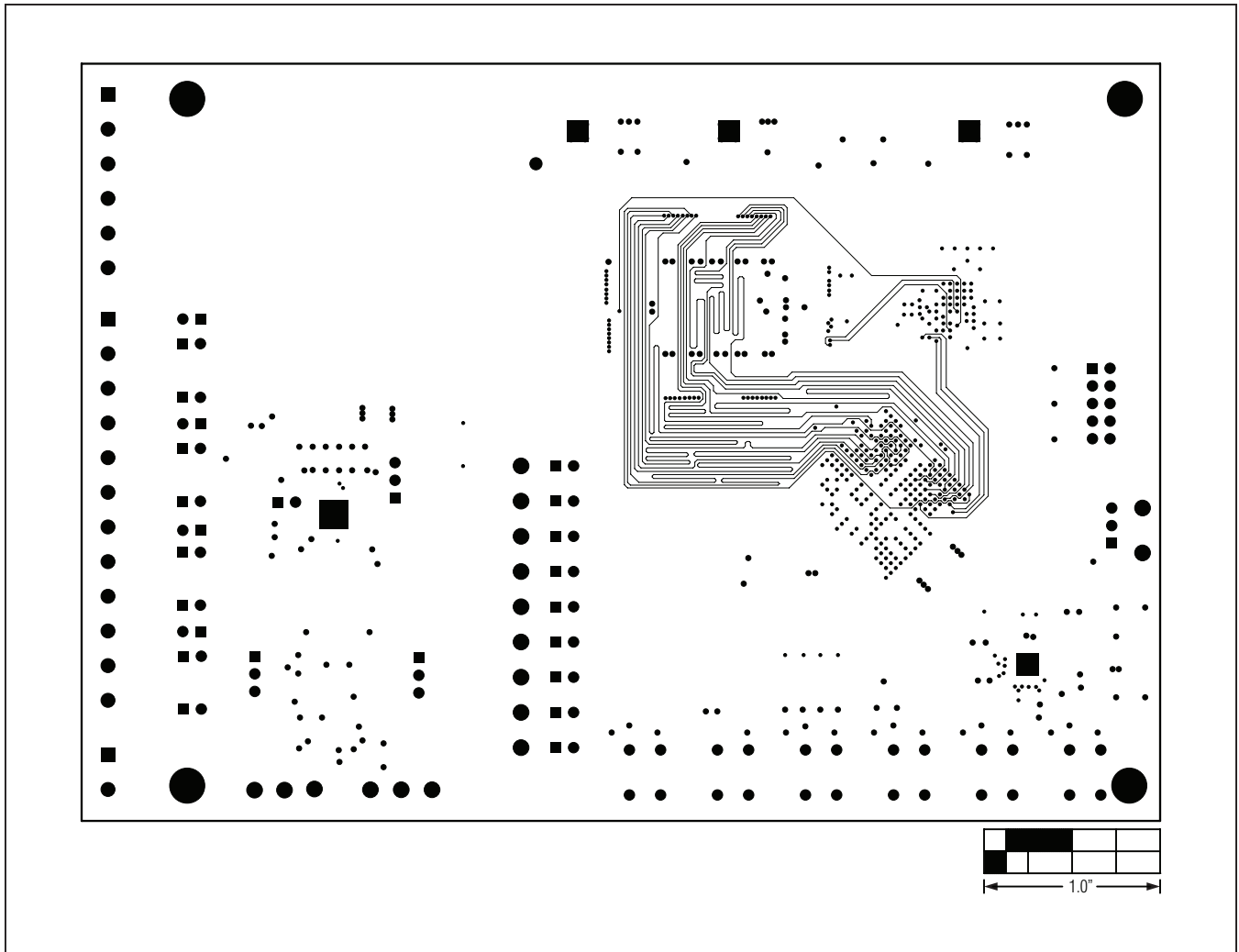

Figure 14. MAX11043 EV Kit PCB Layout—Signal Layer 3

MAX11043ATL Evaluation Kit

Evaluates: MAX11043

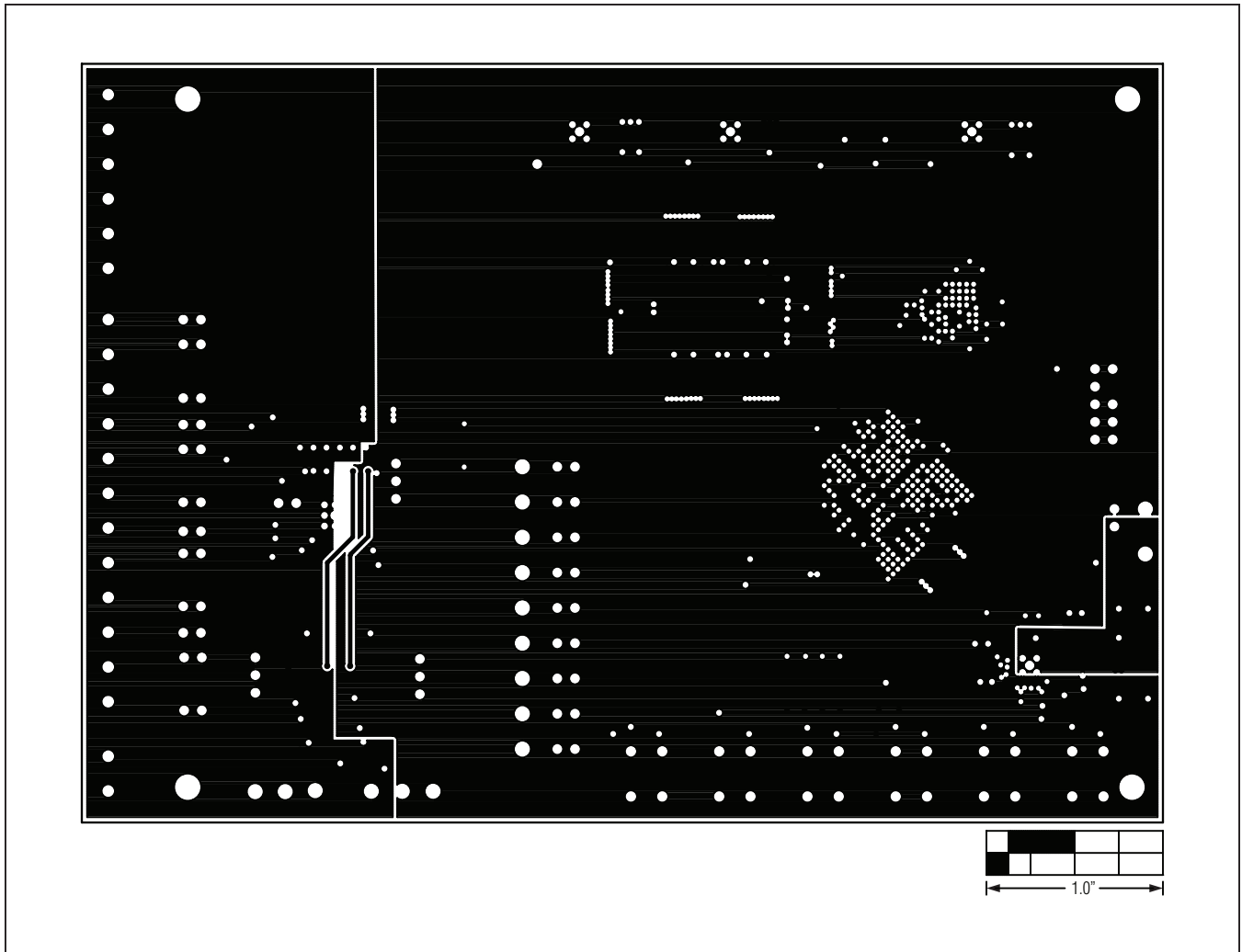

Figure 15. MAX11043 EV Kit PCB Layout—Ground Layer 4

MAX11043ATL Evaluation Kit

Evaluates: MAX11043

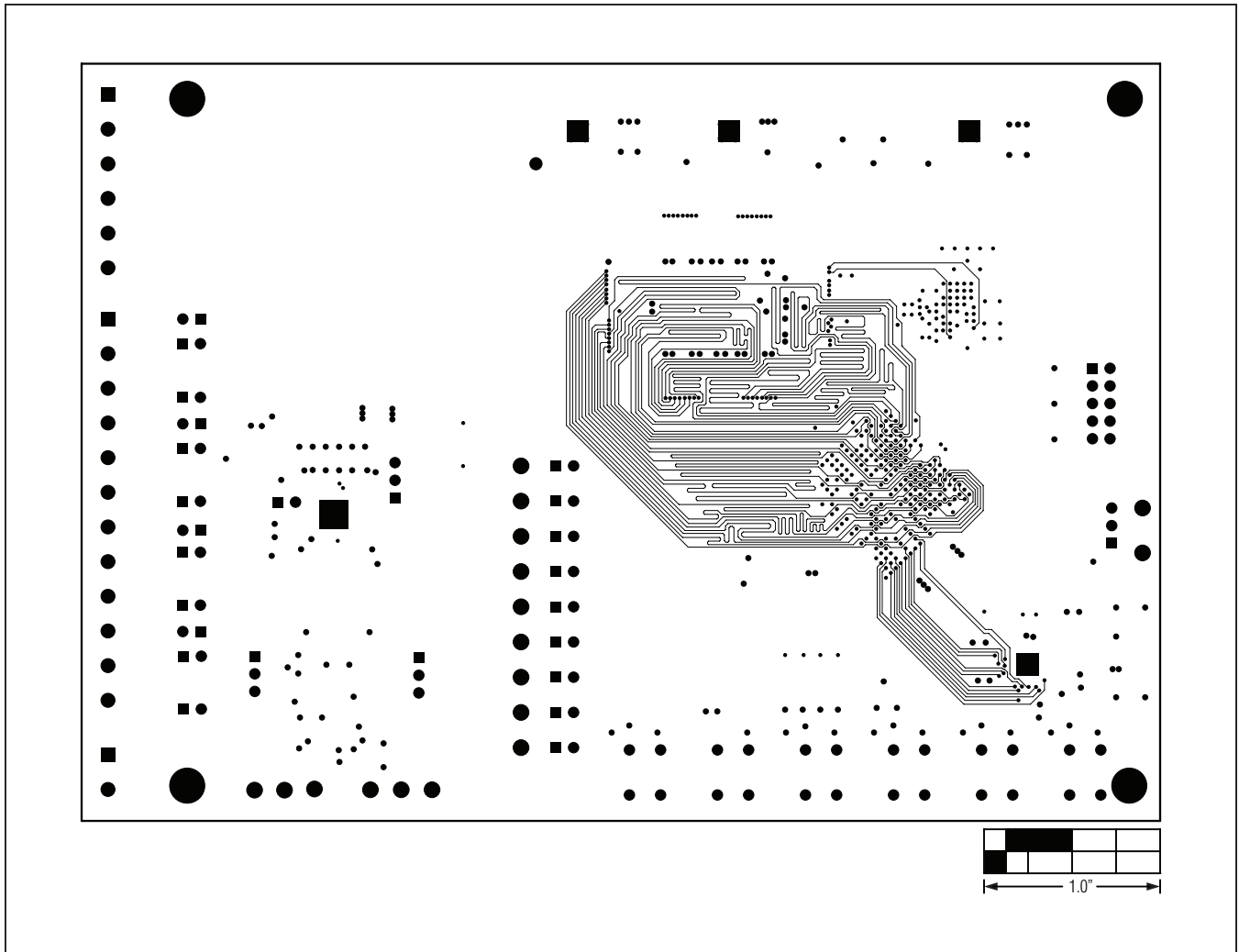

Figure 16. MAX11043 EV Kit PCB Layout—Power Layer 5

MAX11043ATL Evaluation Kit

Evaluates: MAX11043

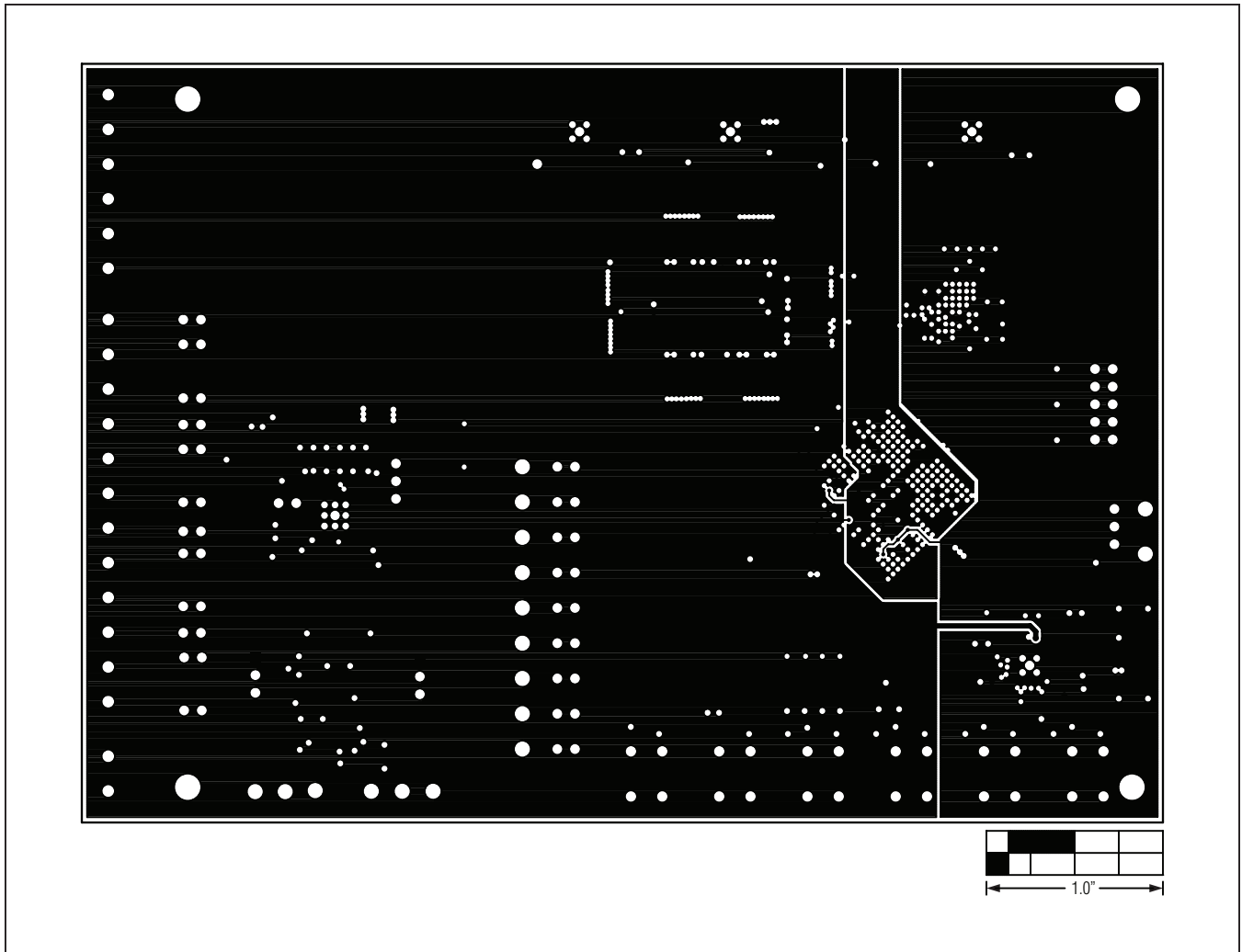

Figure 17. MAX11043 EV Kit PCB Layout—Signal Layer 6

MAX11043ATL Evaluation Kit

Evaluates: MAX11043

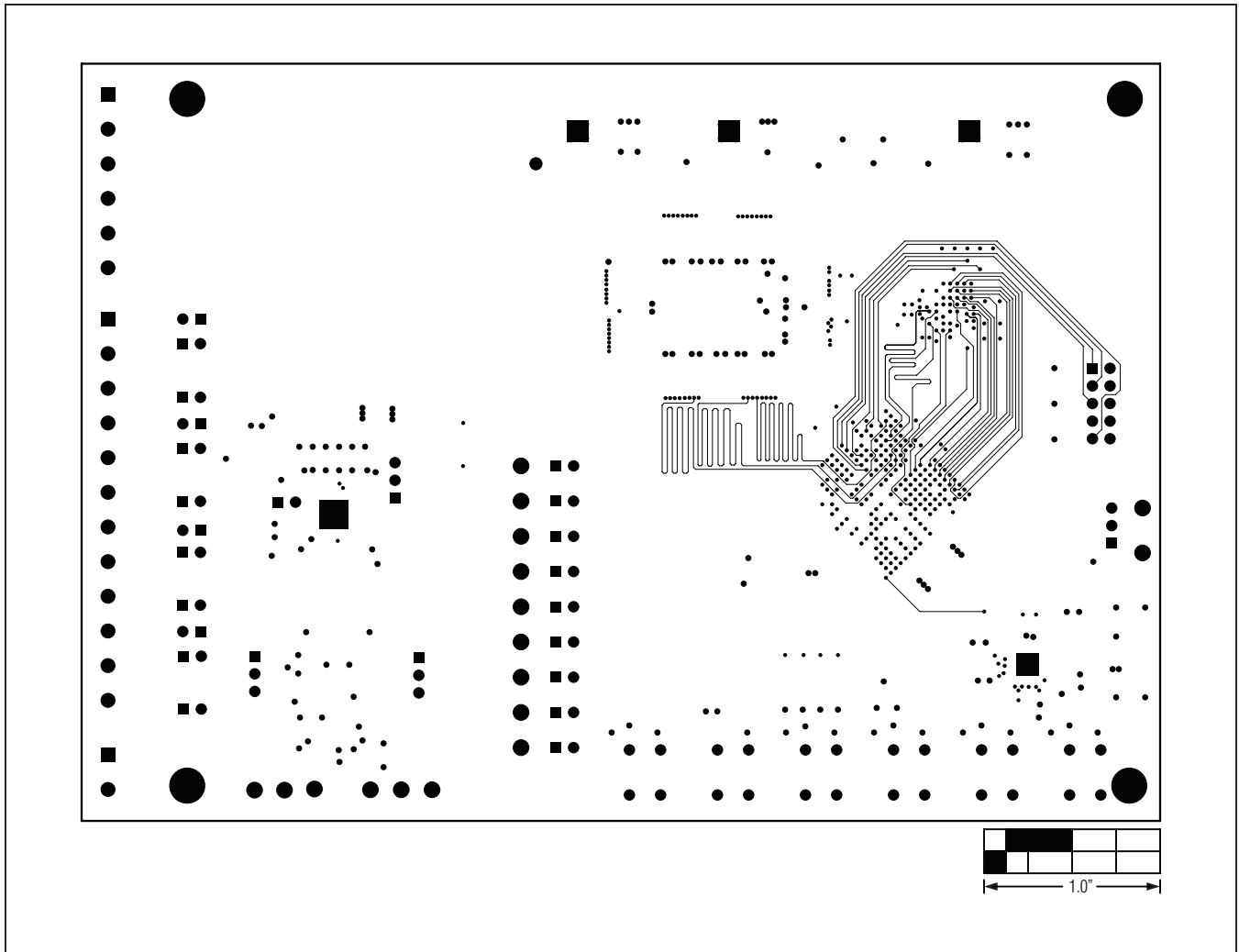

Figure 18. MAX11043 EV Kit PCB Layout—Ground Layer 7

MAX11043ATL Evaluation Kit

Evaluates: MAX11043

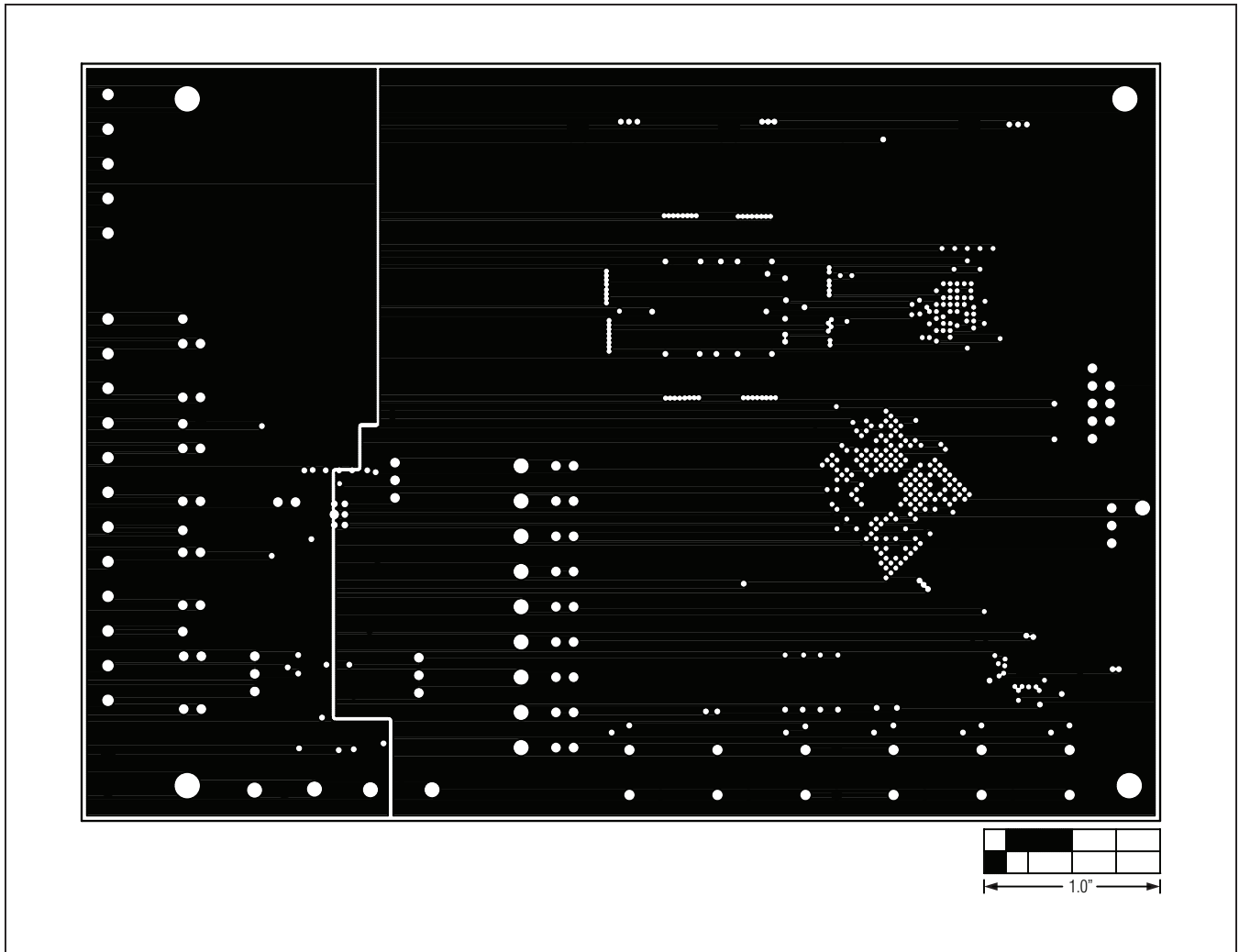

Figure 19. MAX11043 EV Kit PCB Layout—Ground Layer 8

MAX11043ATL Evaluation Kit

Evaluates: MAX11043

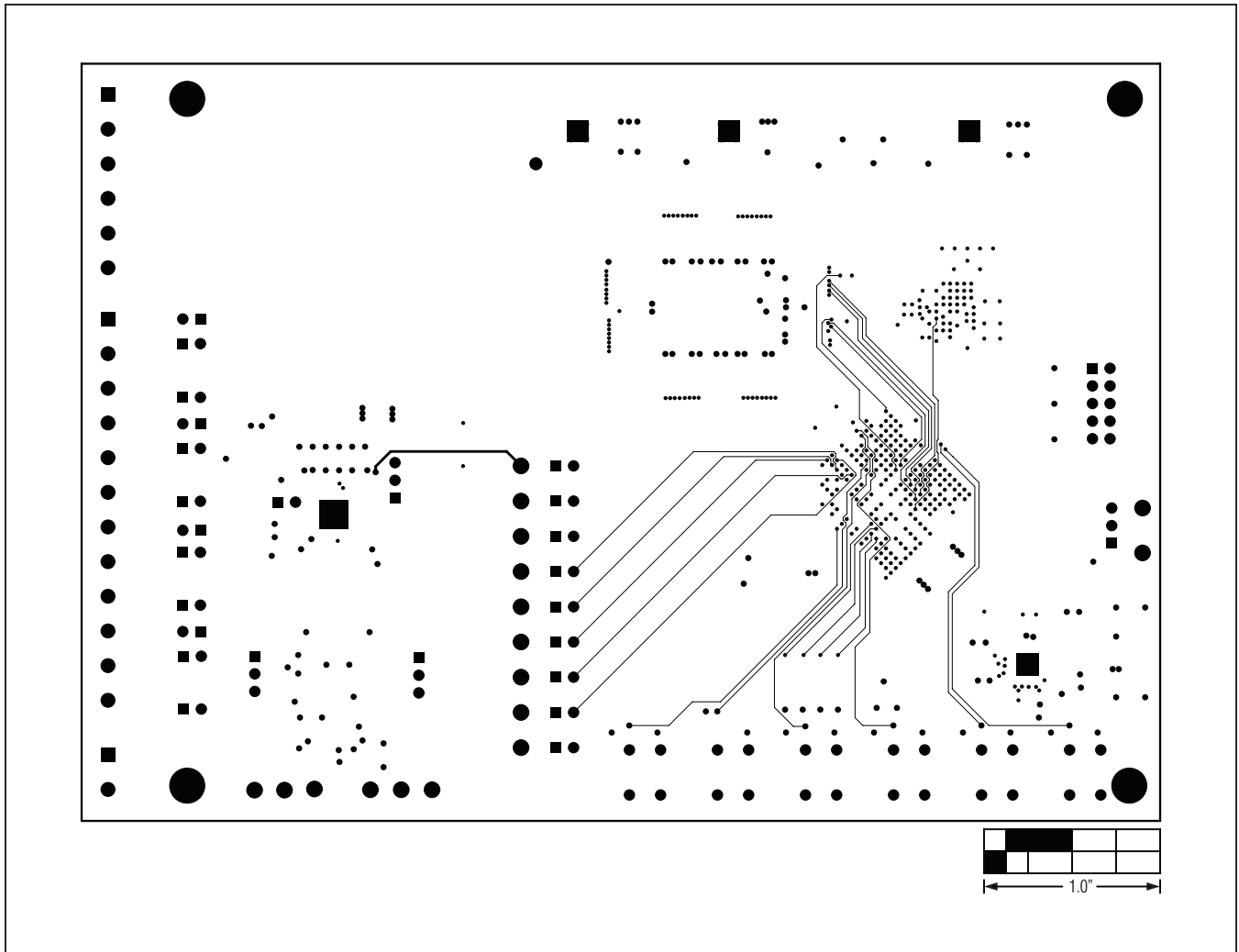

Figure 20. MAX11043 EV Kit PCB Layout—Signal Layer 9

MAX11043ATL Evaluation Kit

Evaluates: MAX11043

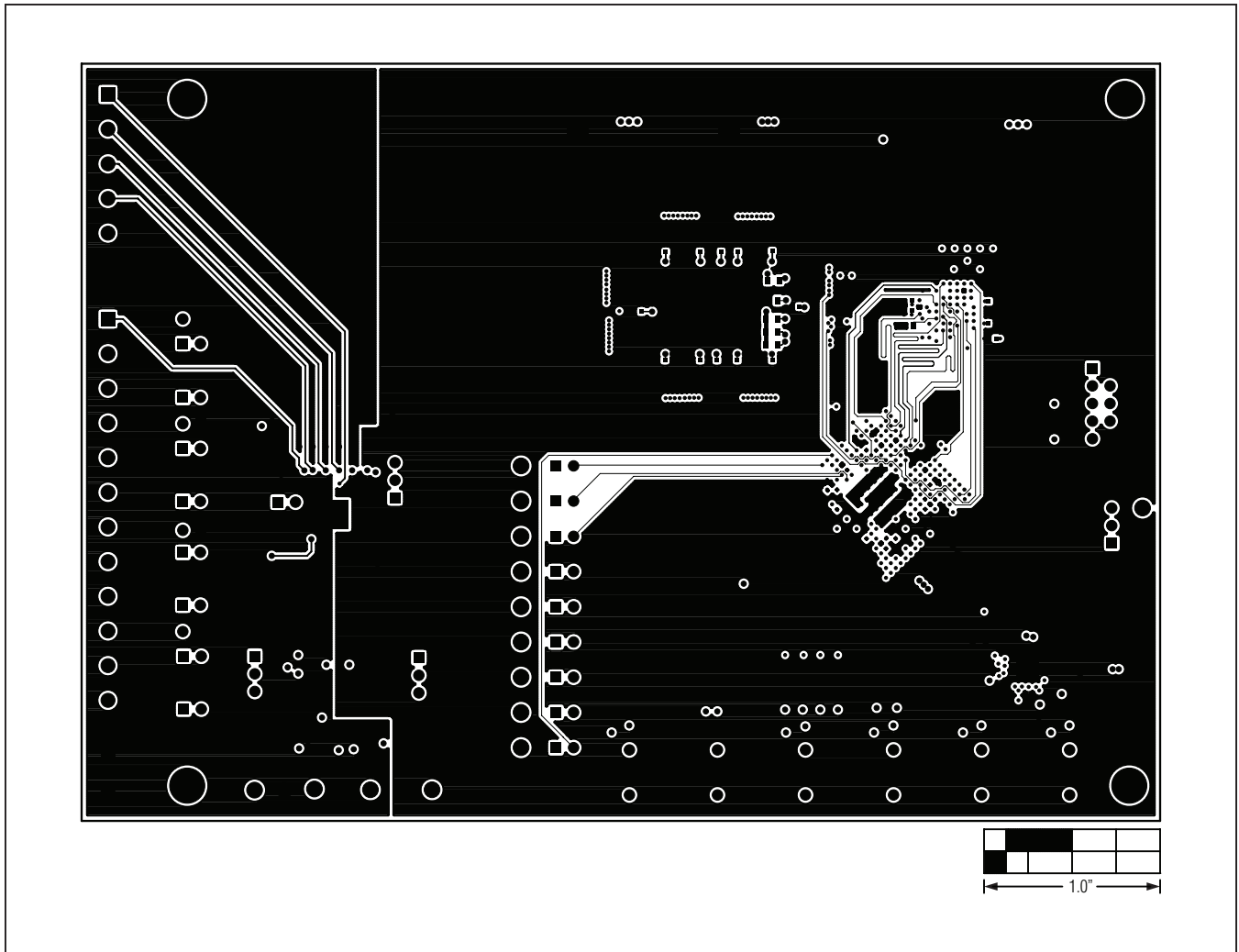

Figure 21. MAX11043 EV Kit PCB Layout—Solder Side

MAX11043ATL Evaluation Kit

Evaluates: MAX11043

Ordering Information

PART	TYPE
MAX11043ATLEVKIT#	EV Kit

#Denotes RoHS compliant.

MAX11043ATL Evaluation Kit

Evaluates: MAX11043

Revision History

REVISION NUMBER	REVISION DATE	DESCRIPTION	PAGES CHANGED
0	5/12	Initial release	—

Maxim cannot assume responsibility for use of any circuitry other than circuitry entirely embodied in a Maxim product. No circuit patent licenses are implied. Maxim reserves the right to change the circuitry and specifications without notice at any time.

Maxim Integrated Products, Inc. 160 Rio Robles Drive, San Jose, CA 95134 USA 1-408-601-1000 _____ 38