

MODEL:

# SRSHELF2P1U

## SmartRack® 1U Cantilever Fixed Shelf



40 lb. Load Capacity



12 in. Platform Depth



Vented Surface for Improved Airflow



Sturdy Steel Construction

- A** 12 in. Platform Depth
- B** Mounting Brackets
- C** Ventilation Slots
- D** Cable Tie Slots
- E** Back-to-Back Installation (≈ 27 in. Total Depth)

Also includes mounting hardware: #12-24 screws (4), M6 cage nuts (4), M6 screws (4) and M6 washers (4).

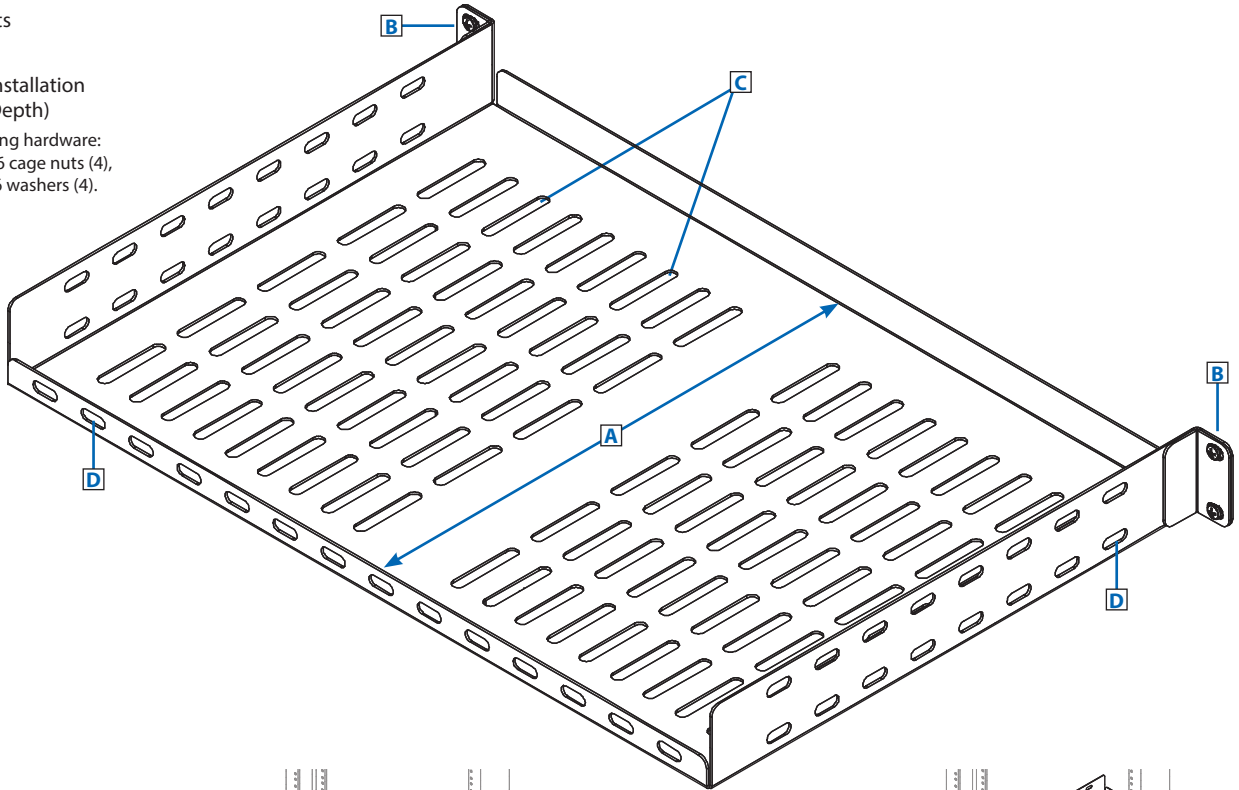

SRSHELF2P1U is a 1U cantilever fixed shelf designed for installation in EIA-compliant 2-post and 4-post racks. It can support up to 40 lb. of equipment, such as tower servers and displays.

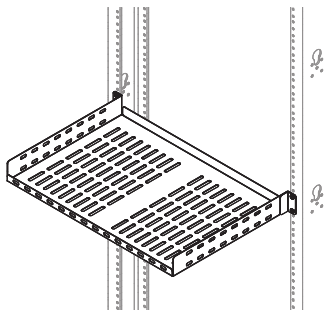

It is possible to install 2 units back-to-back in a 2-post rack to create a deeper shelf in the same 1U rack space.

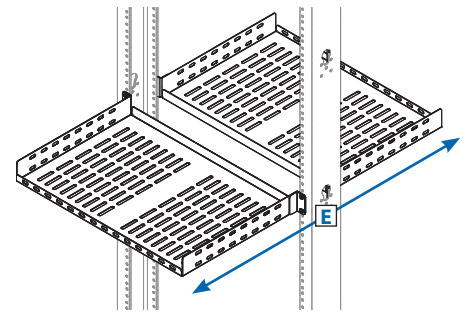

### Specifications



Model	SRSHELF2P1U
Load Rating	40 lb (18 kg)
Unit Dimensions (H x W x D)	1.75 x 19 x 12 in. (44.5 x 482.6 x 304.8 mm)
Shipping Dimensions (H x W x D)	2.5 x 20 x 13.5 in. (63.5 x 508 x 342.9 mm)
Unit Weight	3.5 lb (1.59 kg)
Shipping Weight	4.4 lb (2 kg)
Standards	GOST, RoHS

Tripp Lite has a policy of continuous improvement. Specifications are subject to change without notice.

SEE NEXT PAGE FOR DETAILED UNIT MEASUREMENTS



1111 W. 35th Street  
Chicago, IL 60609 USA  
773.869.1234  
www.tripplite.com

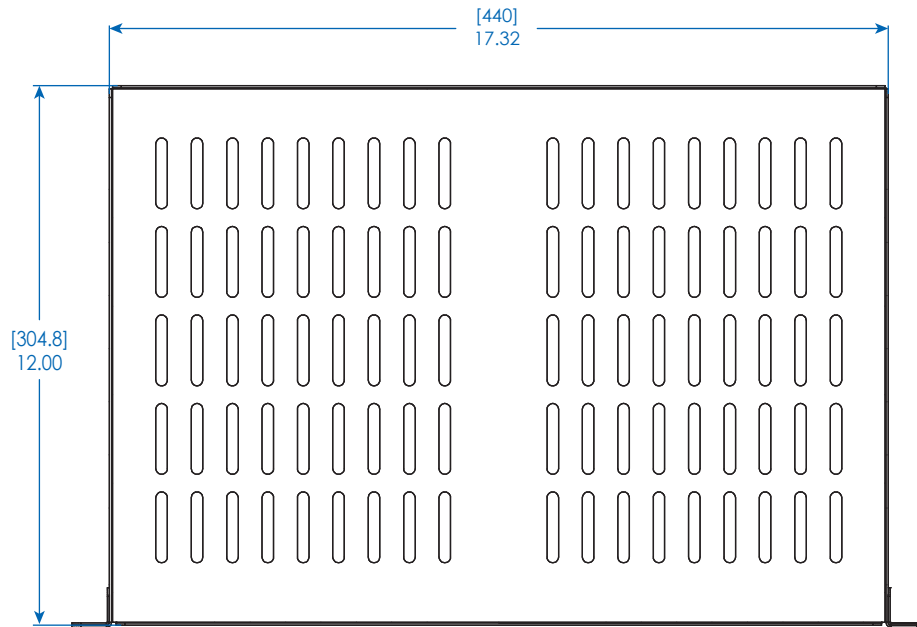

TOP VIEW

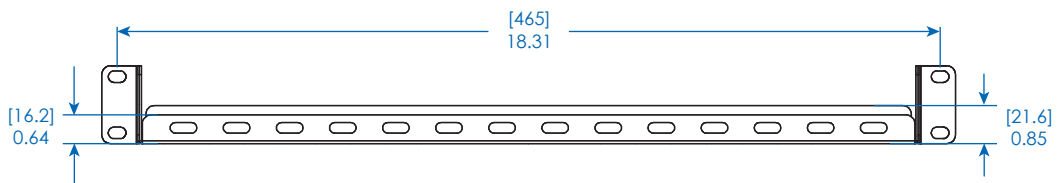

FRONT VIEW

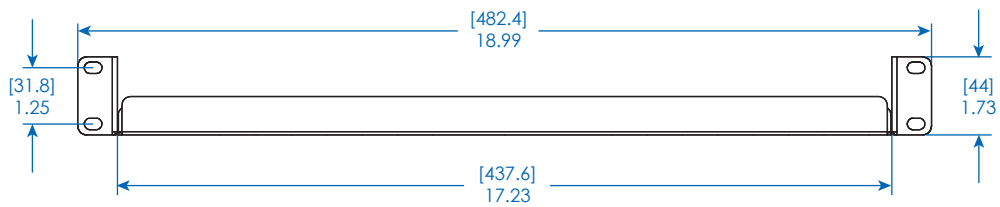

BACK VIEW

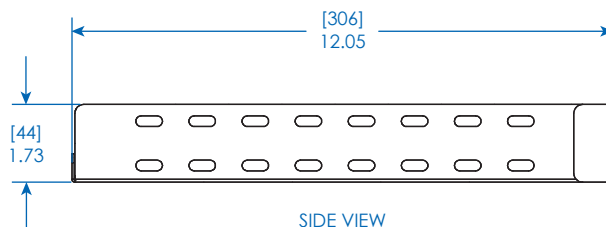

SIDE VIEW

MODEL:  
**SRSHELF2P1U**  
**TRIPP·LITE**

1111 W. 35th Street  
 Chicago, IL 60609 USA  
 773.869.1234  
 www.tripplite.com

Dimensions: [mm] INCHES

Tripp Lite has a policy of continuous improvement. Specifications are subject to change without notice.