

EVALUATION-BOARD for eDIP-series

Issue 03.2015

**PERFECT
DEVELOPMENT TOOL!**

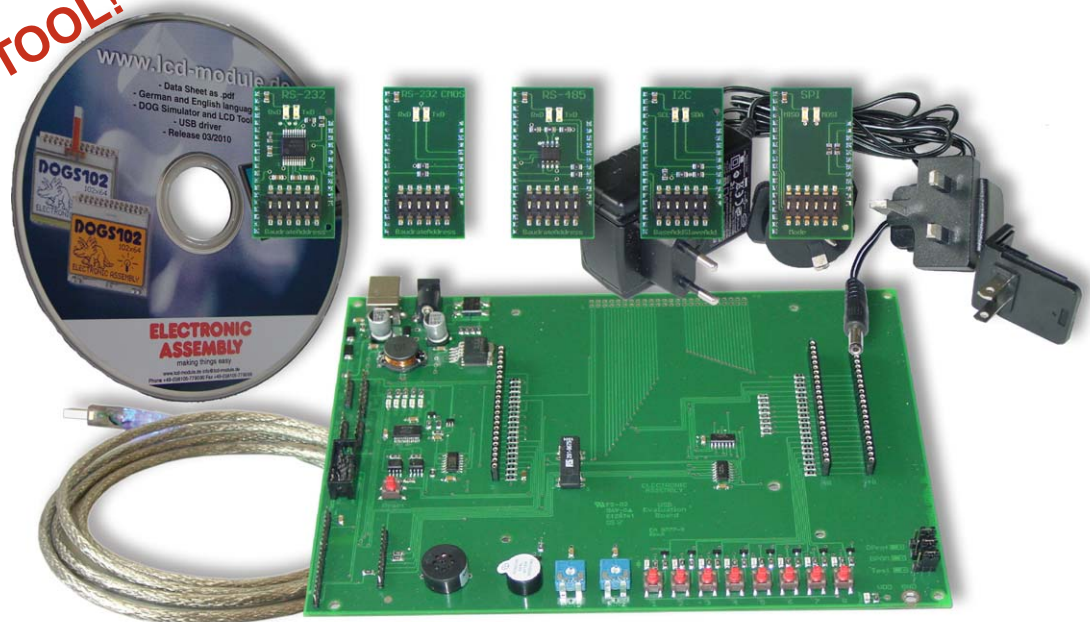

TECHNICAL DATA

- * EVALUATION BOARD DESIGNED FOR SHORTEST DEVELOPMENT TIME
- * USB-INTERFACE TO CONNECT DIRECTLY YOUR PC; NO EXTRA SUPPLY NEEDED
- * BUTTONS, LEDS AND POTENTIOMETERS TO INTERFACE IN- AND OUTPUTS OF THE DISPLAYS
- * LEDS TO SHOW DATA TRAFFIC
- * WIDE VOLTAGE RANGE +3.3V..+5V
- * INCL. USB-CABLE
- * BEEPER AS FEEDBACK FOR TOUCH
- * OPTIONAL ADAPTER BOARD EA 9777-2PE EXPANDS TO ALL INTERFACES:
 - * „REAL“ RS-232
 - * RS-485
 - * I²C (CMOS-LEVEL)
 - * „MICROCONTROLLER“ RS-232 (CMOS-LEVEL)
 - * SPI (CMOS-LEVEL)

ORDERING CODES

STARTERKITS

INCLUDES: Display incl. Touch + EA 9777-3USB + EA 9777-2PE + DVD + USB-Cable

- * EA eDIP320B-8LWTP (320x240 dots, blue/white negative) **EA EVALeDIP320B**
- * EA eDIP320J-8LWTP (320x240 dots, black/white positive) **EA EVALeDIP320J**

INCLUDES: Display incl. Touch + EA 9777-3USB + EA 9777-2PE + AC adaptor + DVD + USB-Cable

- * EA eDIPTFT70-ATP (800x480 dots, 16-Bit color) **EA EVALeDIPTFT70**
- * EA eDIPTFT57-ATP (640x480 dots, 16-Bit color) **EA EVALeDIPTFT57**

SPARE PARTS

EVALUATION BOARD FOR USB (WIN2000/XP/VISTA/7 32+64 bit)
PORT-EXPANSION (RS-232, I2C, SPI, RS485) FOR EA 9777-2USB

EA 9777-3USB
EA 9777-2PE

**ELECTRONIC
ASSEMBLY**
making things easy

Documentation of revision				
Date	Type	Old	New	Reason / Description
2011-05-16	0.1			preliminary version
2011-09-14	1.0			First release

CONTENT

QUICK START	3
EA 9777-3 EVALUATIONBOARD	5
FUNCTION OF POTENTIOMETER	5
FUNCTION OF JUMPER, PUSHBUTTONS, LEDs	6-7
USB-INTERFACE	7
POWER SUPPLY	8
PORT EXPANSION EA 9777-2PE	8
DESCRIPTION PIN CONNECTOR I ² C (EA 9777-3USB)	9
FUNCTION OF DIP-SWITCH I ² C (EA 9777-2PE)	9
DESCRIPTION PIN CONNECTOR RS232, RS485 (EA 9777-3USB)	10
FUNCTION OF DIP-SWITCH RS232, RS485 (EA 9777-2PE)	11
DESCRIPTION PIN CONNECTOR SPI (EA 9777-3USB)	11
FUNCTION OF DIP-SWITCH SPI (EA 9777-2PE)	11
TROUBLESHOOTING	12
SCHEMATIC 9777-2PE	15
SCHEMATIC 9777-3USB	16

QUICK START

1.) Installation

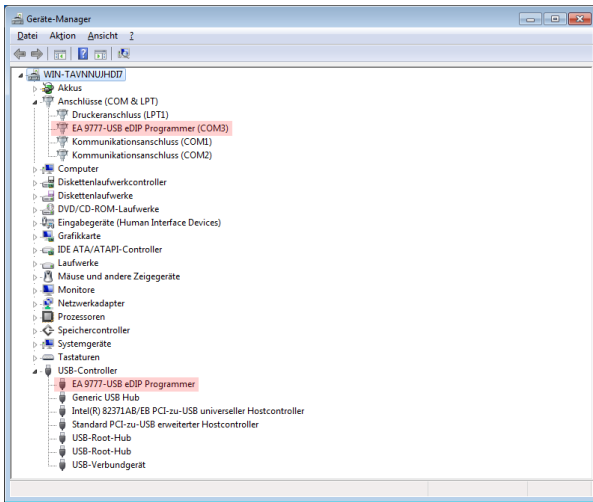

The evaluation board is connected to a free USB-Port of the PC with the delivered USB-cable.

Windows detects the new hardware. Drivers for all supported different Windowsversions are found on the CD in the folder: d:\drivers: After successfully installing the driver, both green LEDs (left and right) will shine.

The EVAL-Boards of the both TFT-displays (EA EVALeDIPTFT57 & EA EVALeDIPTFT70) do need an external power supply. The supplied AC-adaptor has to be plugged in. Once the EVAL-Board is powered the green LED at the bottom right is lit.

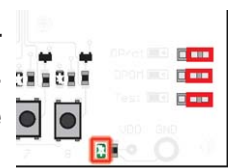
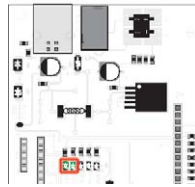

The next step is installing the EA KIT-editor and compiler of eDIP-Series.

The setupfile

“setup LCD-Tools Portable“ is found in the root-directory of the CD. Please follow the instructions of the installer.

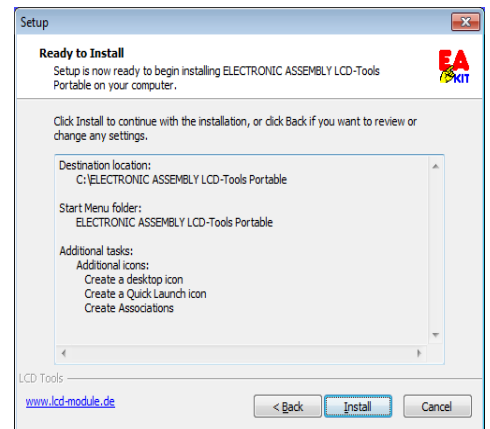

2.) First-time operation of display

Mount your eDIP on the evaluation board. Make sure that it is mounted correctly, pin 1 is placed in the lower left corner.

3.) Compile and flash the display

Run EA KIT-Editor and choose a project. To open a project, please go to the context menu: “File->open“ and select a file (*.kmc). During installation of KIT-Editor some examples are installed, please find them under: <your drive>:\LCD Tools\Data\eDIP - intelligent graphic displays\leDIP???\How to use\. Please make sure to use the right folder, suitable for your module. Please choose a subject you are interested in and open one of the project files.

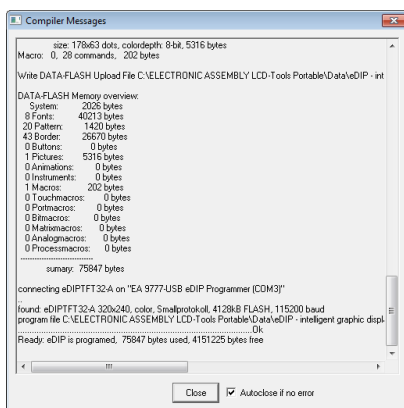
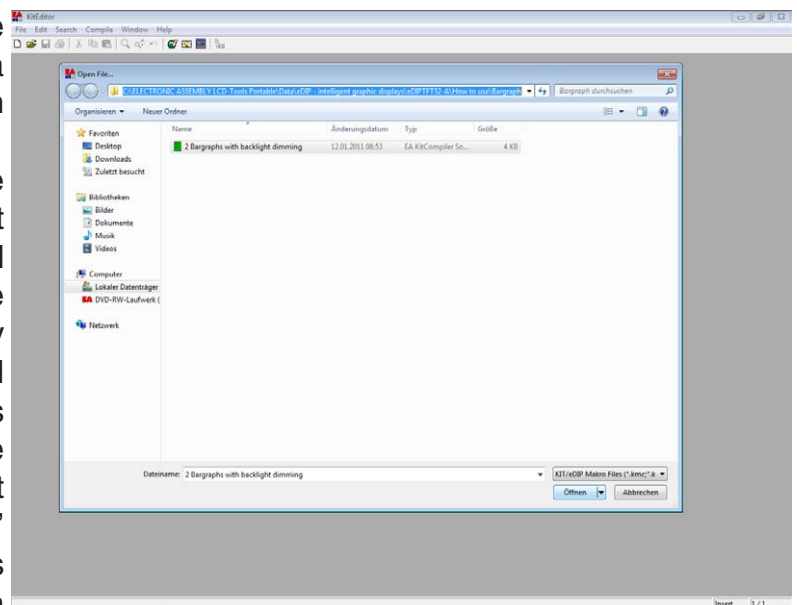

To compile the project and download it onto the module only one additional click is needed. The farrest right icon ‘compile’ starts compilation

and downloads the successfully compiled project automatically to the display.

4.) Useful tool “EA LCD Terminal“

After starting the terminal (from EA KIT-editor: the second icon from the right) a dialog is shown with all present serial interfaces.

Please choose the one labeled with “x: eDIP Programmer (COMx)“. The Evaluation board has the baudrate 115200. Please activate the Small-Protocol (Shift+F8) to exchange data

and commands with the display.

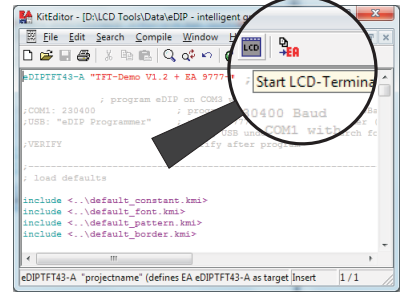
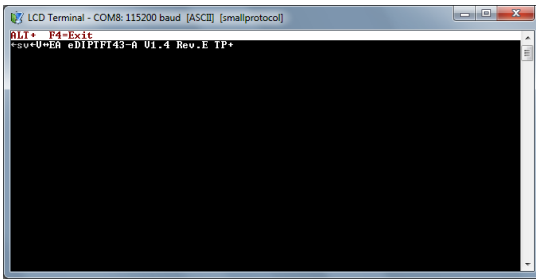

5.) Useful tool “EA BitmapEdit“

The EA BitmapEdit is a simple image processing program. It's designed to use with the eDIP-Series, it can save and load all formats (e.g. *.g16, *.BH7) of EA eDIP-Series.

In addition, you can create elementary animations, by dragging the single pictures onto the editor.

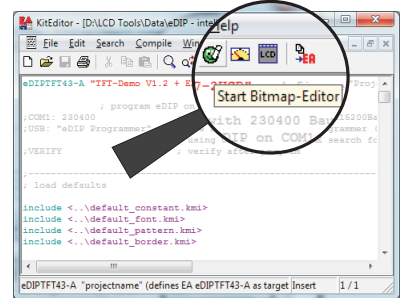
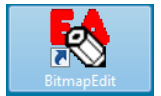
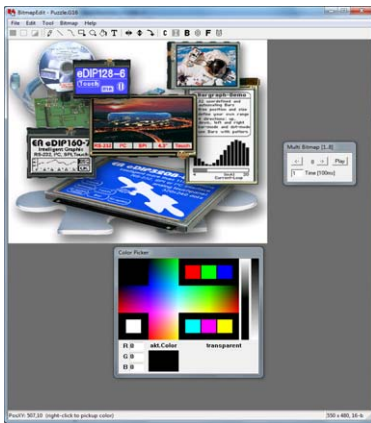

6.) Useful tool “EA Instrument Editor“

The EA eDIPTFT-Series is able to show analogue pointer instruments. To create those instruments you have to use this editor.

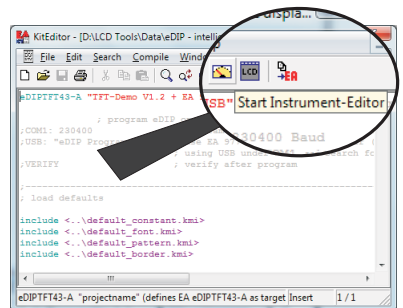

EA 9777-3USB EVALUATIONBOARD

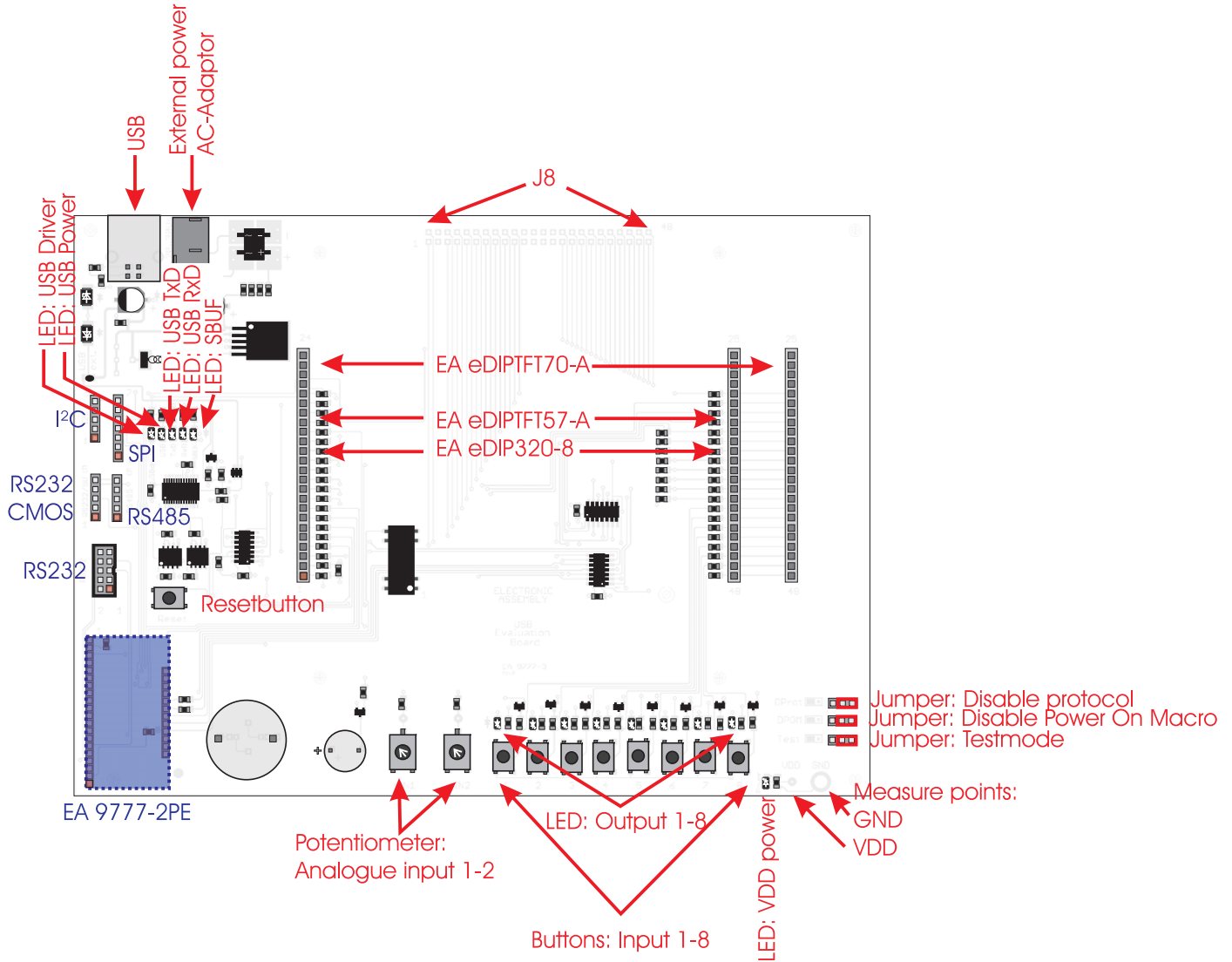

The Evaluation board provides a variety of features, starting with LEDs to indicate data-transfer, ending with potentiometers to use the analogue inputs of EA eDIPTFTs.

The lands J8 are directly connected with the corresponding pin of the eDIP. If you remove the 0R-resistors the periphery is completely disconnected. Please refer to the schematic on the last page.

Note: Not all functions of the Evaluation board are supported by every display of the eDIP-series.

FUNCTION OF POTENTIOMETER

Both potentiometers are connected to the analogue inputs of the eDIPTFTs. They set the voltage of AIN1 and AIN2 between GND and VDD.

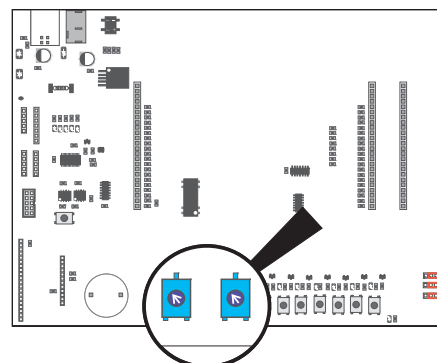

FUNCTION OF JUMPERS

- “Disable Power On Macro“: If a continuous loop is programmed either in PowerOn-, Reset-, Watchdog- or BrownOut-Macro, the display is no longer adressable. In this case you have to restrain the run of Power-On-Macro. This is done by the jumper: Switch power off, set the jumper to the right (DPOM to GND). Now you have to re-power the module and release the jumper or set it to the left (DPOM is open).
- “Disable Protocol“: The small-protocol can be disabled. This might be helpful espacially in the early stage of development. It is strongly recommended to activate the protocol in series, to monitor data-transfer. If the jumper is set to the left, the protocol is deactivated (DPROT to GND). If the jumper is set to the right or left open, the protocol is activated (DPROT open). You have to reset the module if you want to change the protocol-mode.
- “Testmode“: Each eDIP includes a testmode, which can be activated with the help of a jumper: Set the jumper to the left (TEST to GND) and a test screen will be displayed. If you want to change to normal operation you have to release the jumper or set it to the right (TEST open) and reset the module.

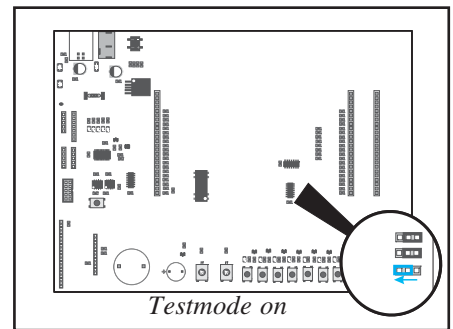
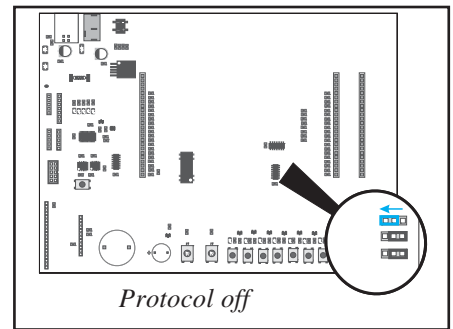
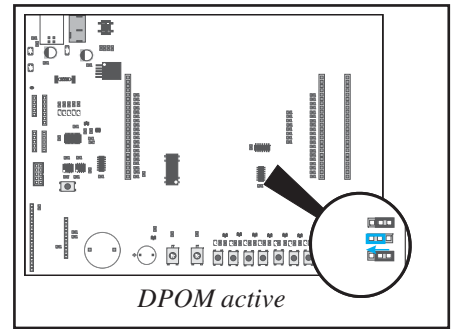

FUNCTION OF LEDS

- “USB-Power“ (green): This LED indicates a connected USB-cable.
- “VDD power“ (green): This LED indicates the Evaluation board to be power-supplied
- “USB-TxD“ (red): This LED indicates data is transferd to the eDIP.
- “USB-RxD“ (green): This LED indicates data is send by the eDIP.
- “SBUF“ (orange): This LED glows if data is present in the sendbuffer of the display (SBUF low).
- “Output 1-8“ (green): These LEDs are directly connected to the outputs of the eDIPTFT. They are lit if the output of eDIPTFT is set to high. The EA eDIP320-8 has no outputs, so this function is not available.

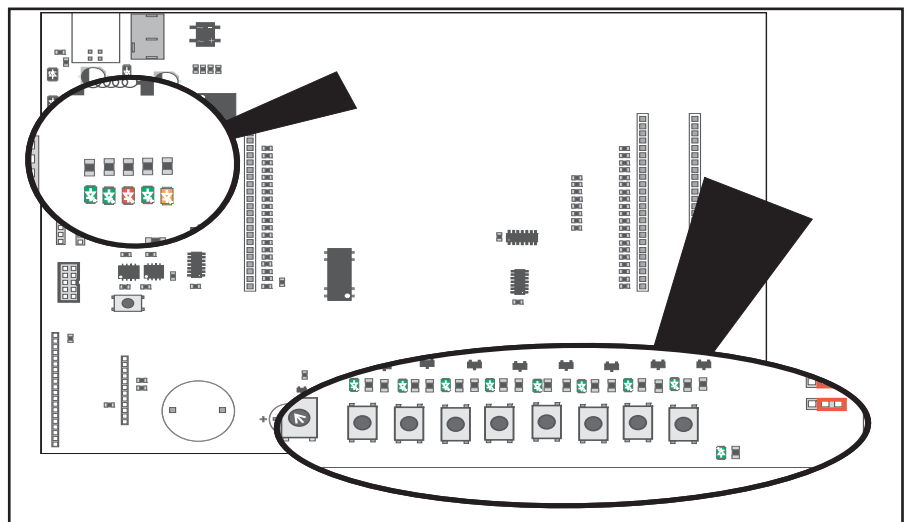

FUNCTION OF PUSHBUTTONS

- “Resetbutton“: As long as you push this button the EA eDIP is in Reset mode (RESET to GND). After release of button PowerOnMacro is run.
- “Input 1-8“: These 8 buttons are directly connected to the inputs of the EA eDIPTFTs. If you push a button the corresponding input is grounded. Please refer to the schematic on the last page of this datasheet.

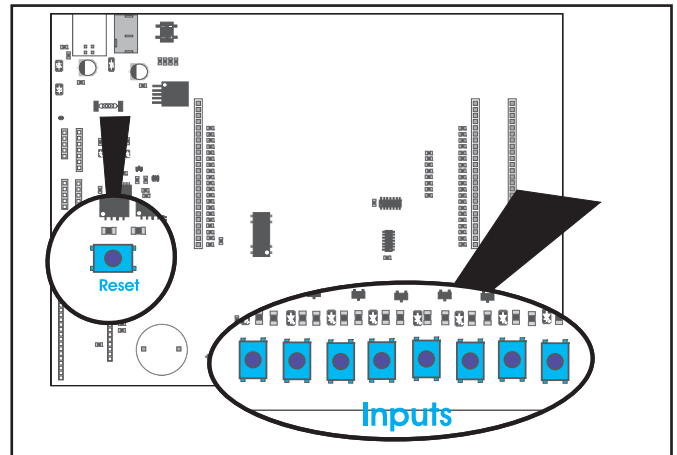

USB-INTERFACE

The Evaluation board is connected to a free USB-port of your PC using the supplied USB-cable. The USB-Interface is located at the upper left corner of the Evaluation board.

If you connect the USB-cable, the LED “USB-Power“ (green) is on. If the driver for Windows is installed correctly the LED “USB driver“ is also lit.

The scope of delivery includes a CD on which you can find the drivers for the board under “d:\Driver\“. These drivers are designed for Windows 2000, XP, Vista, 7. To install the drivers please follow the instructions of your operating system.

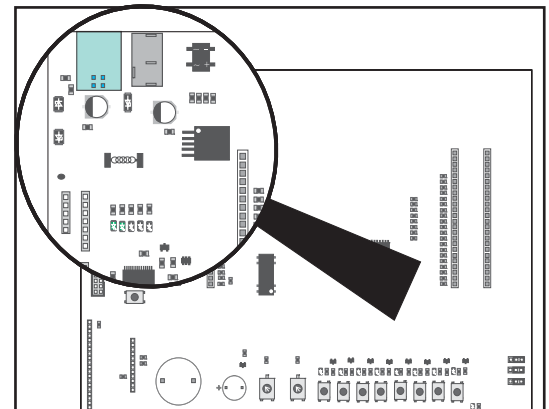

(EXTERNAL) POWERSUPPLY

The EVAL-board has a 2.1 mm power socket for external supply. The supply range is between 12V to 28VAC.

External supply is optional if you are using the starterkit EA EVLAeDIP320, i.e. normally power over USB is used.

Both of the starterkits of EA eDIPTFT-series need external supply, an AC-adapter is included with your delivery.

The supply source is selected by a solder bridge, which is preset correctly.

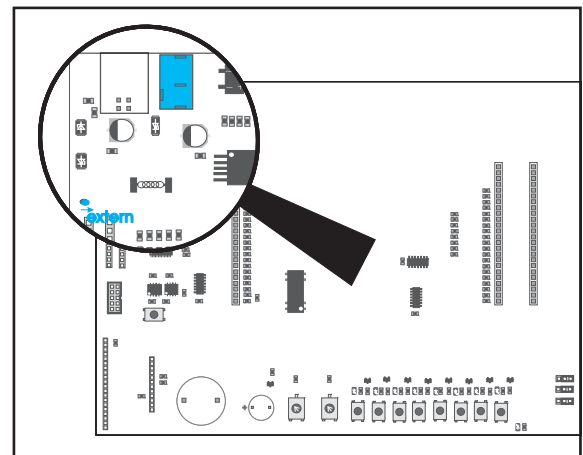

PIN CONNECTORS OF THE BOARD IN CONNECTION WITH INTERFACE EXPANTION

The pin coennectors, you can see on the board EA 9777-3USB provide the repective interfaces.

Attention:

The following description of pin connectors are only operable if the optional available adapter board EA9777-2PE is mounted.

PORT EXPANSION EA 9777-2PE (included in EA EVALxxx)

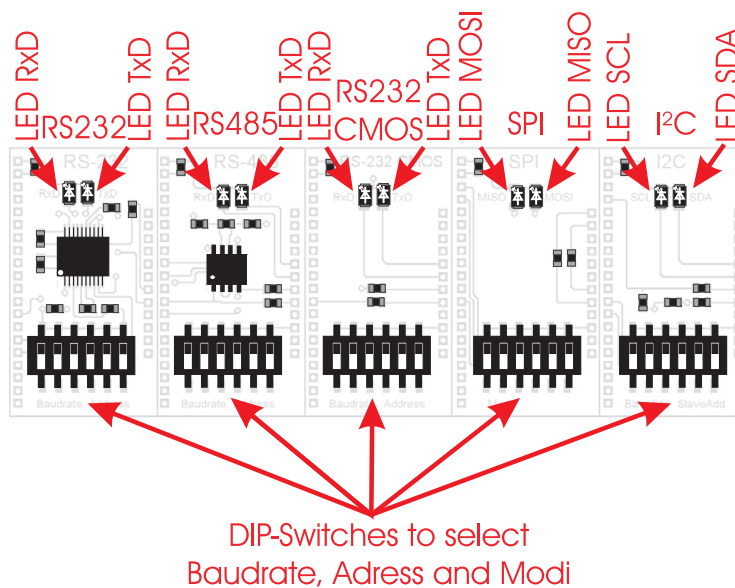

The optional adapter board EA 9777-2PE expands the Evaluation board with important interfaces: "real" RS232, RS232 CMOS, RS485, SPI and I2C.

The board consists of 5 individual adapter boards, which have to be carefully broken asunder the perforation.

Each adapter board has two LEDs two indicate data transfer. In addition there is a DIP-Switch.

The adapters intermit the USB connection between Evaluation board and PC and configures the eDIP for the desired interface. Please make sure to reset the display every time you change the interfaces. To reuse the USB connection again, you have to removethe adapter board and reset the display.

I²C

Pin connector EA 9777-3USB

Pin 9777-2	Symbol	Function	Pin eDIP
1	GND	Ground potential for logic (0V)	1
2	VDD	Power supply for logic (3.3V ... 5V)	2
3	SDA	Serial data line	14
4	SCL	Serial clock line	15
5	SBUF	data in sendbuffer (low)	20

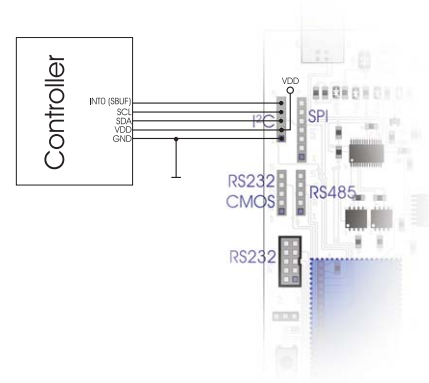

DIP-Switch setting: I²C (EA 9777-2PE)

The DIP-Switch settings can be found in the table depending on the desired mode. The first three switches change the base adress, the last three the slave adress of the eDIP.

For further information on the interface and data transfer please refer to the respective data sheet of the eDIP.

DIP-Switch	Base-adress	DIP-Switch	Slaveadress
	\$10		\$00
	\$20		\$02
	\$30		\$04
	\$40		\$06
	\$70		\$08
	\$90		\$0A
	\$B0		\$0C
	\$D0 ^{*1)}		\$0E ^{*1)}

RS232 +/-12V

Pin connector EA 9777-3USB

Pin 9777-2	Symbol	Function	Pin eDIP
1	VDD	Power supply for logic (3.3V ... 5V)	2
2	DCD		---
3	DSR		---
4	TxD	Transmit Data	[11]
5	CTS		---
6	RxD	Receive Data	[10]
7	RTS		---
8	DTR		---
9	NC.	Not connected	---
10	GND		1

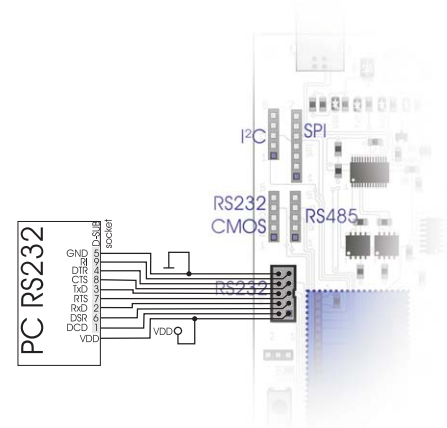

Note:

There is a interface cable available under ordering code EA KV24-9B. It allows a direct connection to a PC. The length of the cable is 1.5m.

RS232 CMOS

Pin connector EA 9777-3USB

Pin 9777-2	Symbol	Function	Pin eDIP
1	GND	Ground potential for logic (0V)	1
2	VDD	Power supply for logic (3.3V ... 5V)	2
3	RxD	Receive data	10
4	TxD	Transmit data	11
5	SBUF	data in sendbuffer (low)	20

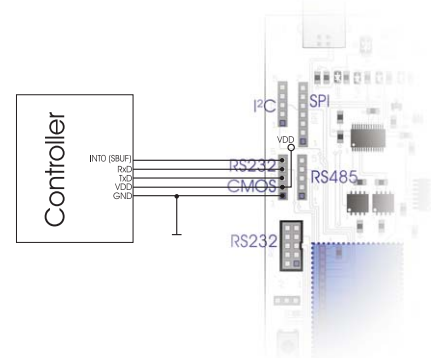

RS485

Pin connector EA 9777-3USB

Pin 9777-2	Symbol	Function	Pin eDIP
1	GND	Ground potential for logic (0V)	1
2	VDD	Power supply for logic (3.3V ... 5V)	2
3	A	RS485 A (Data +)	---
4	B	RS485 B (Data -)	---
5	SBUF	data in sendbuffer (low)	20

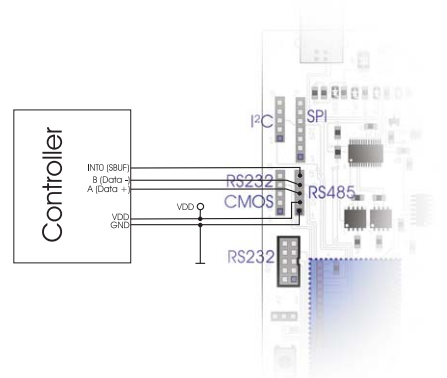













DIP-Switch setting: RS232, RS485, RS232 CMOS (EA 9777-2PE)

The DIP-Switch settings can be found in the table depending on the desired mode.

The first three switches change the baudrate, the last three the address of the eDIP.

For further information on the interface and data transfer please refer to the respective data sheet of the eDIP.

DIP-Switch	Baudrate	DIP-Switch	Adress
	2400		0
	4800		1
	9600		2
	19200		3
	38400		4
	57600		5
	115200 *1)		6
	230400		7 *1)

SPI

Pin connector EA 9777-3USB



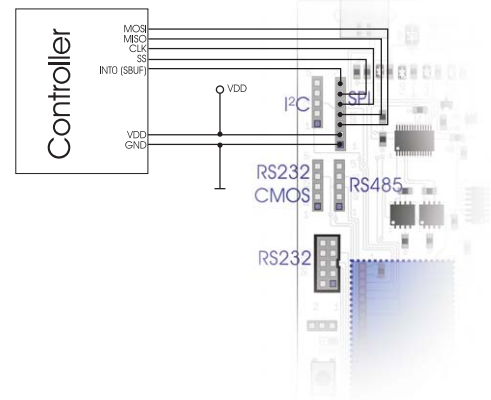



Pin 9777-2	Symbol	Function	Pin eDIP
1	GND	Ground potential for logic (0V)	1
2	VDD	Power supply for logic (3.3V ... 5V)	2
3	MOSI	Serial in	7
4	MISO	Serial out	8
5	CLK	Shift clock	9
6	SS	Slave select	6
7	SBUF	data in sendbuffer (low)	20



DIP-Switch setting: SPI-Interface (EA 9777-2PE)

The DIP-Switch settings can be found in the table depending on the desired mode.

DIP-Switch 2 and 3 are connected to CPHA and CPOL. Data order is acuated by the first switch. For further information on the interface and data transfer please refer to the respective data sheet of the eDIP.

DIP-Switch	SPI-Mode	DIP-Switch	Data-order
	0		MSB first
	1		LSB first *1)
	2		
	3 *1)		

*1):Default setting

TROUBLESHOOTING

- Display not flashing:

Please check the power supply. The LED (Power-LED), placed on the lower right corner has to glow green. If you supply with USB the solder bridge “Select power“ must be positioned on the left and the driver for Windows must be installed. If you supply externally, please set the solder bridge to the right.

- No connection to USB:

Check the installation of the USB-driver, with the help of device manager of Windows. In addition make sure, that no board of the Port-Expansion (EA 9777-2PE) adaptors are mounted. Please reset the display after removing the adaptor-board.

- No connectin to RS232 (+/-12V):

Please check if you have installed the adaptor-board of Interface Expansion EA 9777-2PE correctly and reset the display. Also check the wiring of RS232 between your PC and the board EA 9777-3USB. There is a interface cable available under ordering code EA KV24-9B. It allows a direct connection to a PC. The length of the cable is 1.5m. If there is still a problem, please have a look on the DIP-Switches, which set the baudrate and adress. It's recommended to use the defaults. Further information you will find on pages 10 and 11.

- No connection to RS232 (CMOS):

Please check if you have installed the adaptor-board of Interface Expansion EA 9777-2PE correctly and reset the display. Also check the wiring of RS232 between your controller and the board EA 9777-3USB. If there is still a problem, please have a look on the DIP-Switches, which set the baudrate and adress. It's recommended to use the defaults. Further information can be found on pages 10 and 11.

- No connection to RS485 (CMOS):

Please check if you have installed the adaptor-board of Interface Expansion EA 9777-2PE correctly and reset the display. Also check the wiring of RS485 between your controller, the other stations and the board EA 9777-3USB. If there is still a problem, please have a look on the DIP-Switches, which set the baudrate and adress. It's recommended to use the defaults. Further information can be found on pages 10 and 11.

- No connection to SPI:

Please check if you have installed the adaptor-board of Interface Expansion EA 9777-2PE correctly and reset the display. Also check the wiring of SPI between your controller, the other stations and the board EA 9777-3USB. If there is still a problem, please have a look on the DIP-Switches, which set the baudrate and adress. It's recommended to use the defaults. Further information can be found on page 11.

- No connection to I²C:

Please check if you have installed the adaptor-board of Interface Expansion EA 9777-2PE correctly and reset the display. Also check the wiring of I²C between your controller, the other stations and the board EA 9777-3USB. If there is still a problem, please have a look on the DIP-Switches, which set the baudrate and adress. It's recommended to use the defaults. Further information can be found on page 11.

NOTES

NOTES

SCHEMATIC 9777-2PE

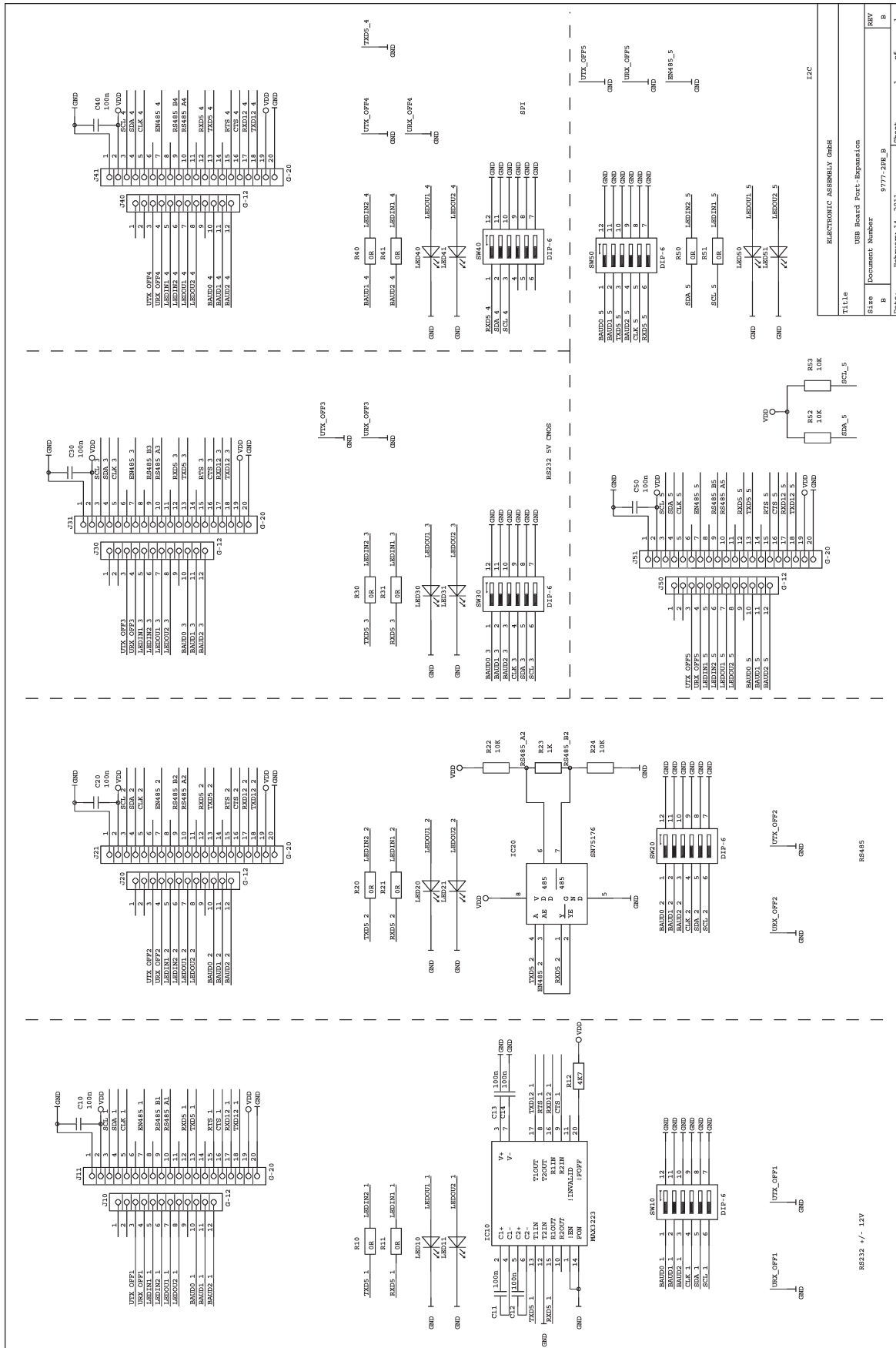

Title		RELECTRONIC ASSEMBLY GmbH	
Size		USB Board Port-Expansion	
Docu. Number		9777-2PE_B	
Date:		February 14, 2011	
Sheet		1 of 1	

SCHEMATIC 9777-3USB

