

REVISIONS				
P.	LTM	DESCRIPTION	DATE	APPROV
H5		ADD NEW DASH NUMBER	24APR2014	CZ SZ

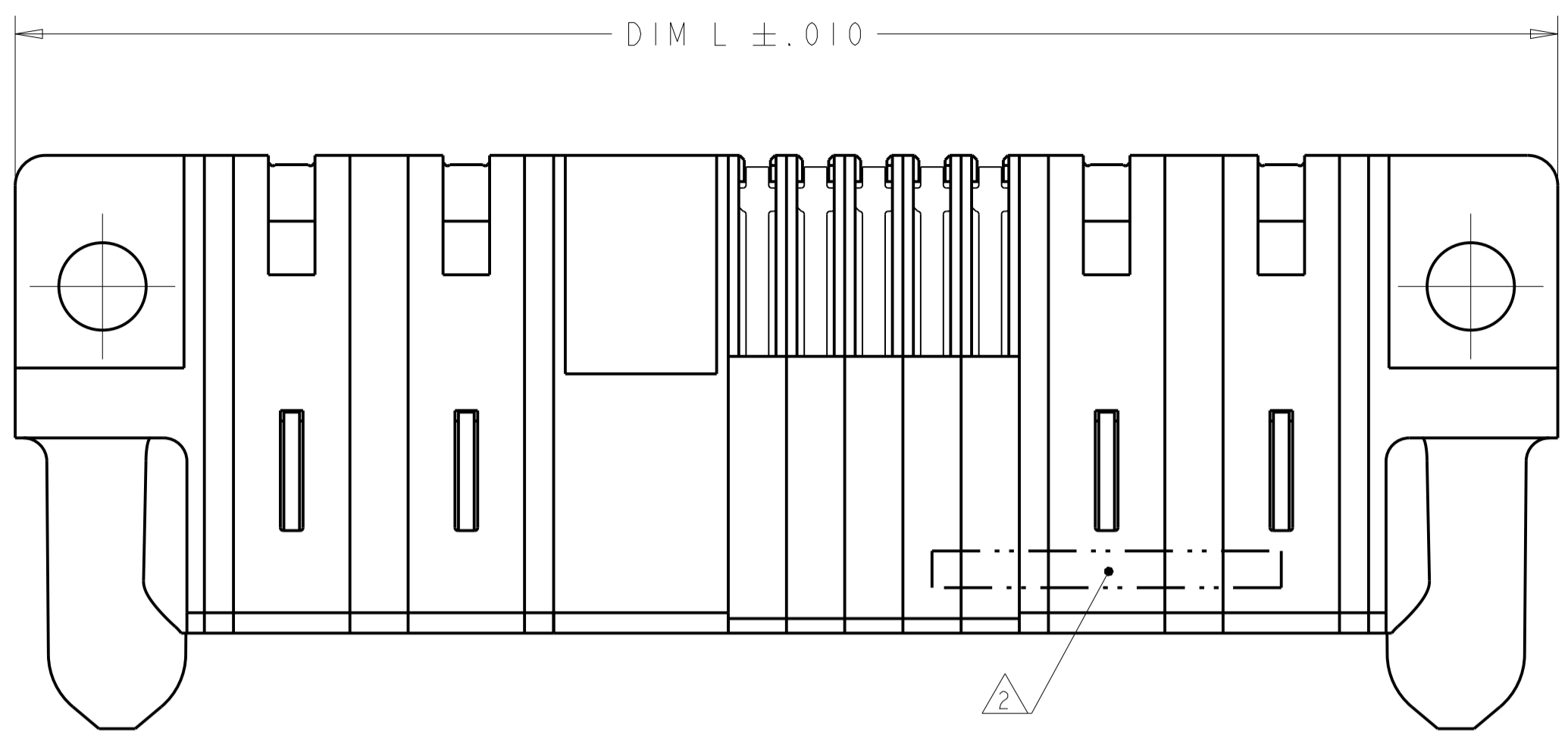

- 1 OPTIONAL CENTER MODULE, WITH .150 THRU HOLE OR HOLD DOWN FEATURE.
- 2 "AMP", PART NUMBER, AND DATE CODE TO BE MARKED IN AREA SHOWN.
- 3 MATERIAL: HOUSING - GLASS FILLED HIGH TEMP THERMO PLASTIC, UL94 V-O, BLACK.  
SIGNAL CONTACT - HIGH CONDUCTIVITY COPPER ALLOY  
POWER CONTACT - HIGH CONDUCTIVITY COPPER ALLOY
- 4 CONTACT PLATING: NOBLE METAL PLATING ON CONTACT FUNCTIONAL AREA OF POWER AND SIGNAL CONTACTS
- 5 MECHANICAL CONNECTOR KEEP OUT ZONE.
- 6 DATUM AND BASIC DIMENSIONS ESTABLISHED BY CUSTOMER.
- 7 PCB - ALL HOLE DIAMETERS ARE FINISHED HOLE SIZES.
- 8 PCB - 0.0453 +/- .0010 DRILLED HOLES PLATED WITH .0003 MIN. Sn OVER .001 TO .003 CU PLATING TO ACHIEVE A .040±.003 HOLE.
- 9 VARIABLE DIMENSION SHOW ON VIEW (SHEET 3).

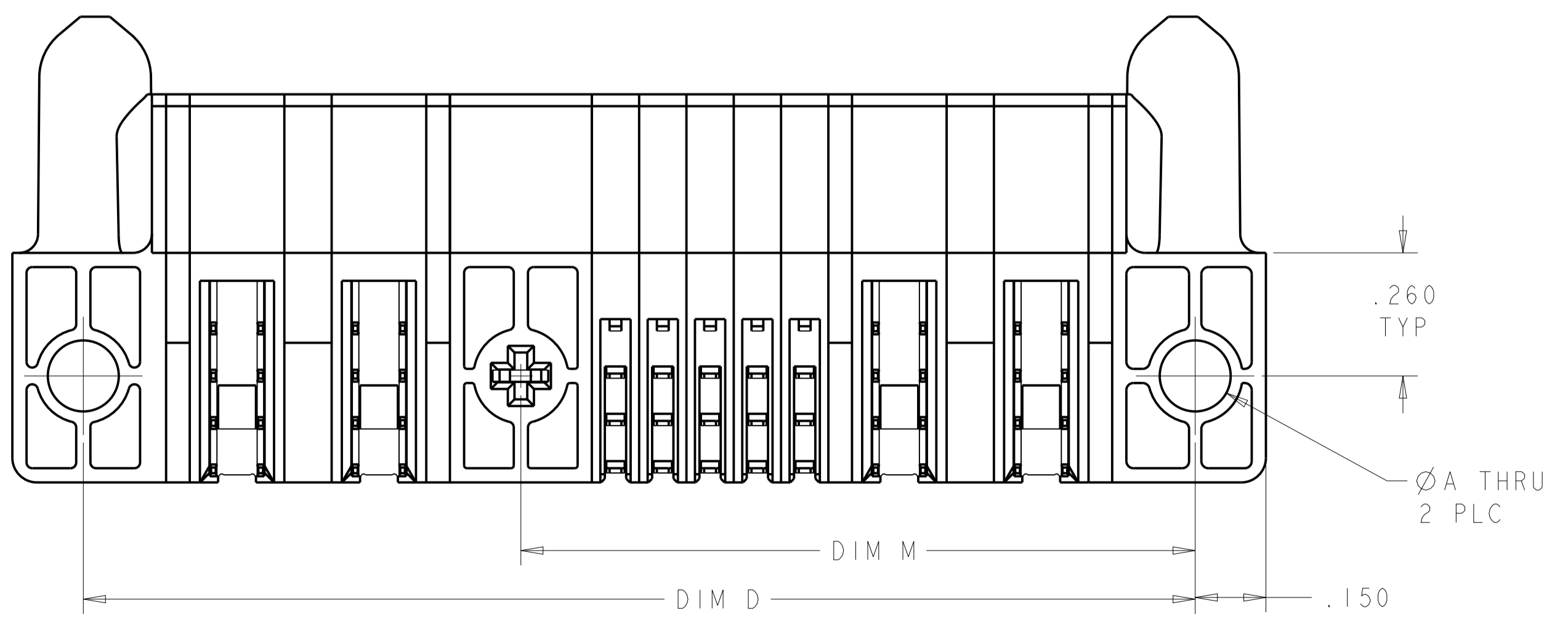
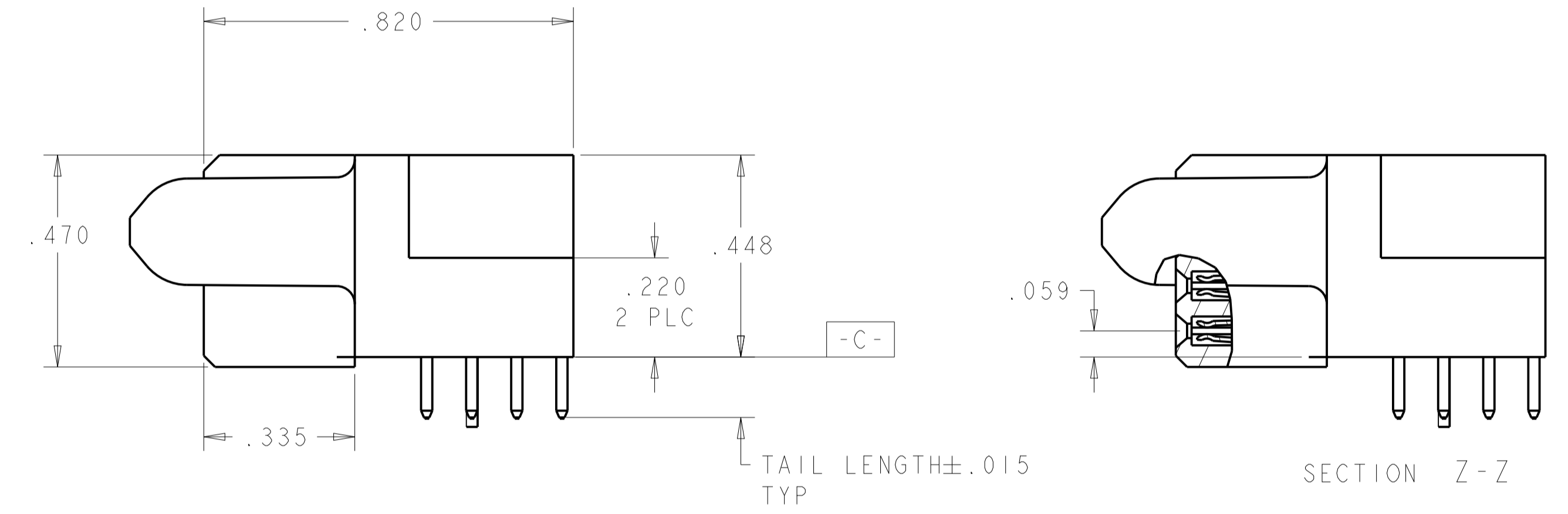
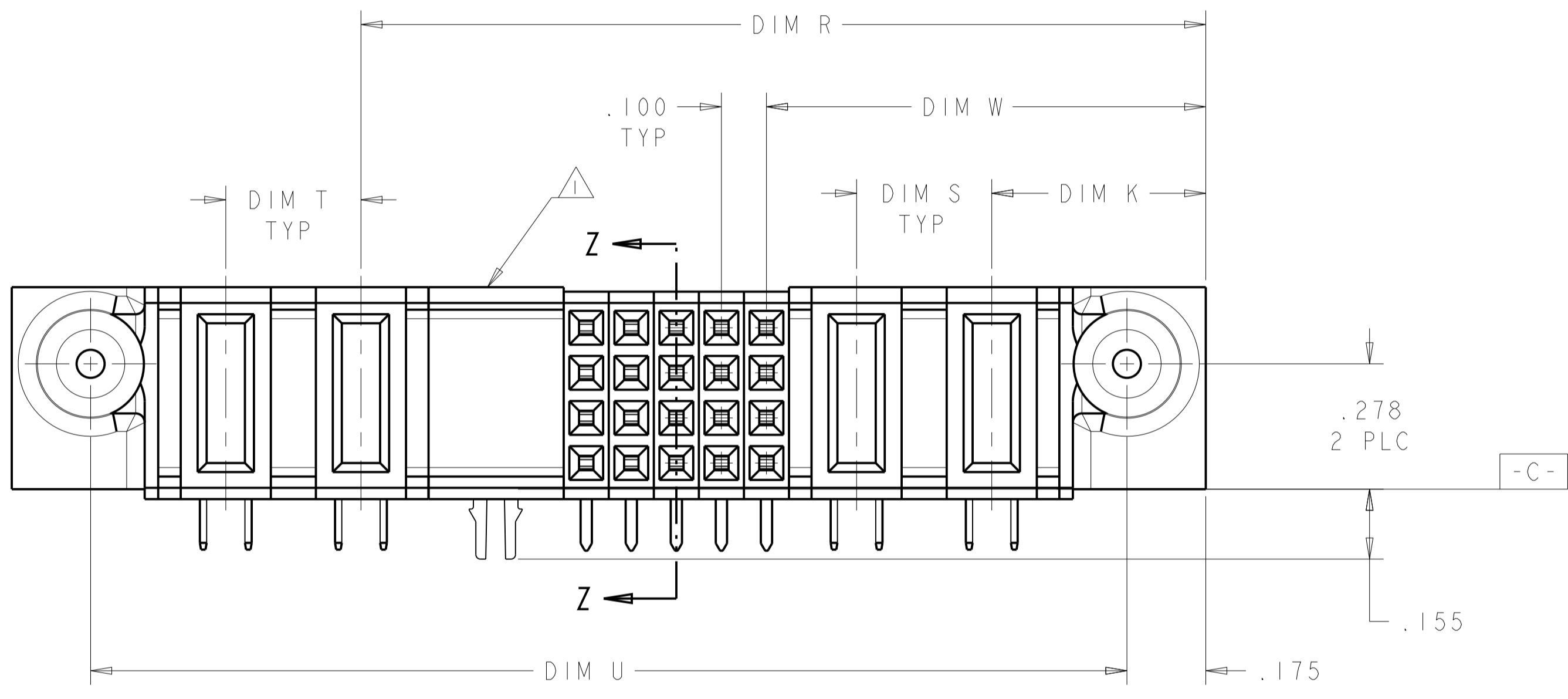

DIM A	DIM T	DIM S	DIM U	DIM R	DIM W	DIM D	DIM M	DIM L	DIM K	DESCRIPTION	PART NUMBER
.122	-	.250	2.750	2.650	1.375	2.800	-	3.100	.450	4P + 48S + 1P	1-6450360-6
.122	-	.200	2.700	2.600	1.425	2.750	-	3.050	.450	5P+44S+1P	1-6450360-5
.150	.200	.200	1.600	1.300	.825	1.650	-	1.950	.450	2HDP + 16S + 2HDP	1-6450360-4
.150	.200	.200	2.400	2.100	.825	2.450	-	2.750	.450	2P + 48S + 2P	1-6450360-3
.150	-	-	1.200	1.100	.625	1.250	-	1.550	.450	1P + 16S + 1P	1-6450360-2
.150	9	.250	2.550	1.550	.875	2.600	-	2.900	.450	2P + 24S + 1P + 3ACP	1-6450360-1
.150	.200	9	2.750	1.450	1.175	2.800	-	3.100	.450	3P + 8S + 7HDP	1-6450360-0
.150	.300	.250	3.200	2.475	1.875	3.250	-	3.550	.450	6P + 16S + 3ACP	6450360-9
.150	.250	.250	1.600	1.250	.925	1.650	-	1.950	.450	2P + 8S + 2P	6450360-8
.150	.250	.250	1.600	1.250	.875	1.650	-	1.950	.450	2P + 12S + 2P	6450360-7
.150	.300	.300	2.000	1.575	.975	2.050	-	2.350	.475	2P + 20S + 2P	6450360-1

THIS DRAWING IS A CONTROLLED DOCUMENT.

DIMENSIONS: INCHES

TOLERANCES UNLESS OTHERWISE SPECIFIED:

0 PLC	±.01
1 PLC	±.01
2 PLC	±.01
3 PLC	±.005
4 PLC	±.002
ANGLES	±.020

MATERIAL: 3

FINISH: 4

THIS DRAWING IS A CONTROLLED DOCUMENT. DWN: R. GRZYBOWSKI, CHK: M. PERCHERKE, APVD: M. PERCHERKE

OBAPROS 08APROS

NAME: RIGHT ANGLE RECEPTACLE ASSEMBLY WITH GUIDES MULTI-BEAM XL

PRODUCT SPEC: 108-1973

APPLICATION SPEC: 114-13038

SIZE: A1, CAGE CODE: 6450360, DRAWING NO: 100779

RESTRICTED TO: CUSTOMER DRAWING

SCALE: 4:1, SHEET: 1 OF 6, REV: H5

PART NUMBER	ROWS	POWER		SIGNAL					POWER	
		P4	P3	5	4	3	2	1	P2	P1
6450360-1	D C B A	RA	RA	H	H	H	H	H	RA	RA
				G	G	G	G	G		
				F	F	F	F	F		
2P + 20S + 2P				E	E	E	E	E		

PART NUMBER	ROWS	POWER		SIGNAL		POWER	
		P4	P3	2	1	P2	P1
6450360-8	D C B A	RM	RM	H	H	RM	RM
				G	G		
				F	F		
2P + 8S + 2P				E	E		

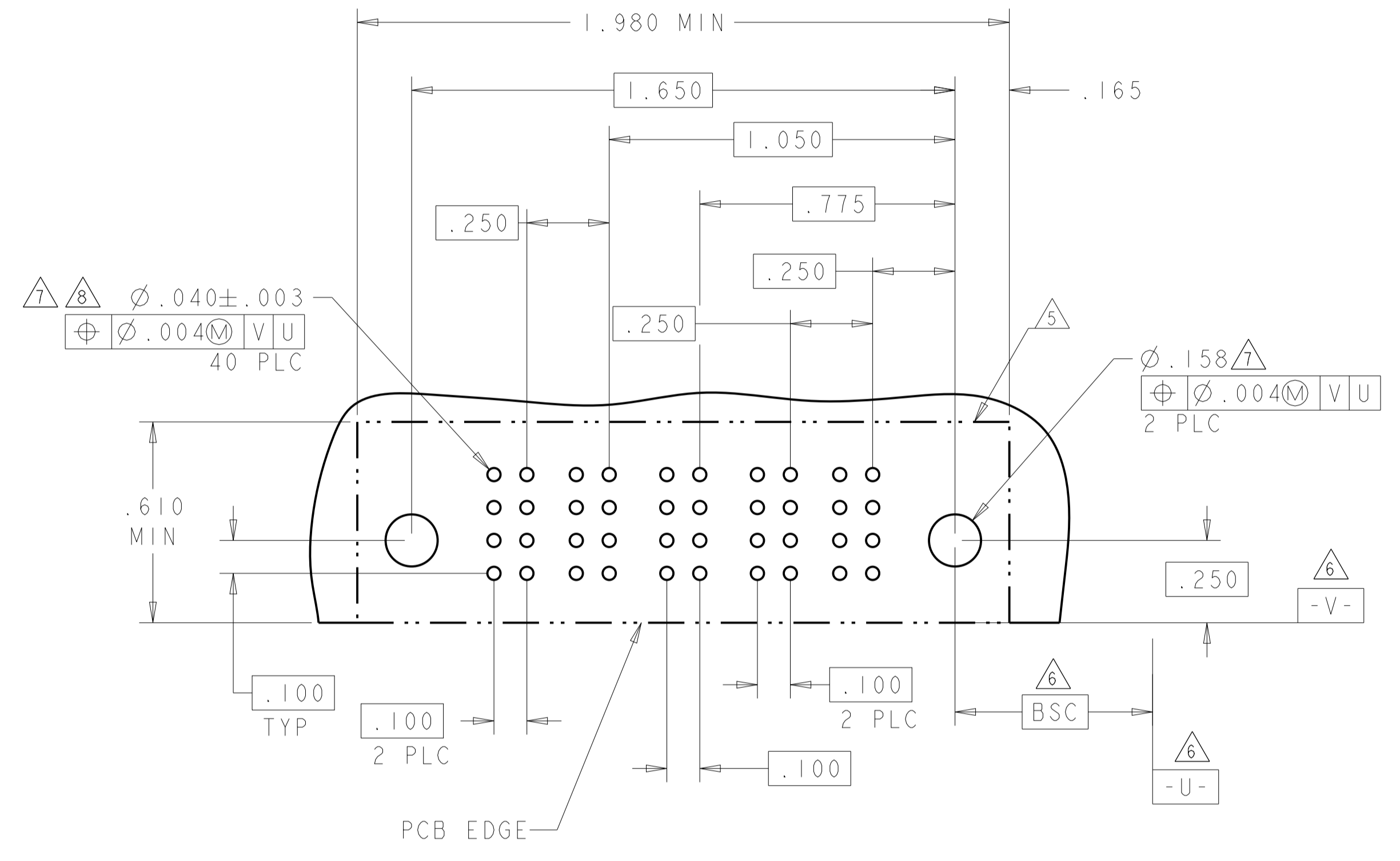
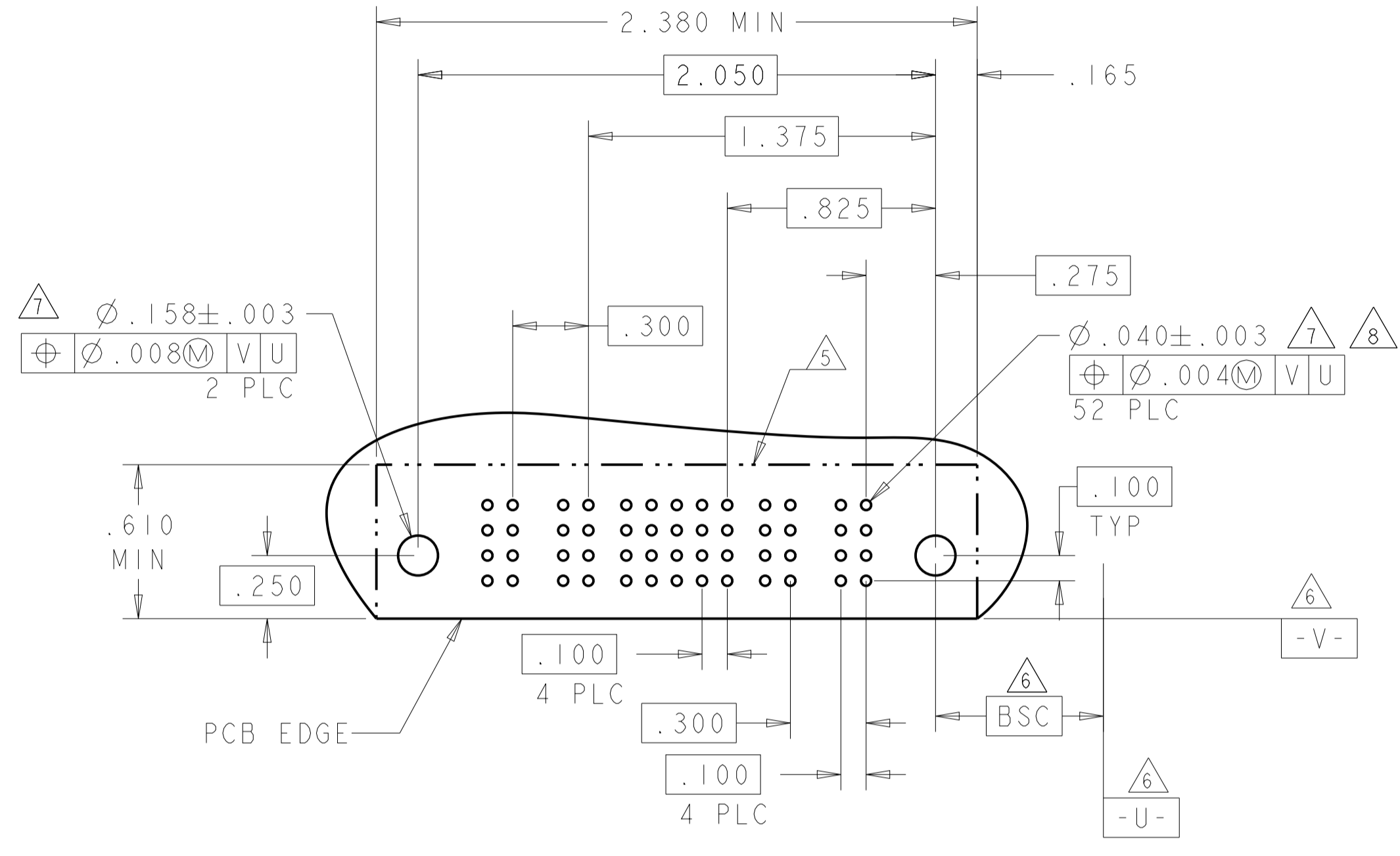

PART NUMBER	ROWS	POWER			SIGNAL				POWER					
		P9	P8	P7	4	3	2	1	P6	P5	P4	P3	P2	P1
6450360-9	D C B A	RM	RM	RM	H	H	H	H	RM	RM	RM	RM	RM	RM
					G	G	G	G						
					F	F	F	F						
6P + 16S + 3ACP					E	E	E	E						

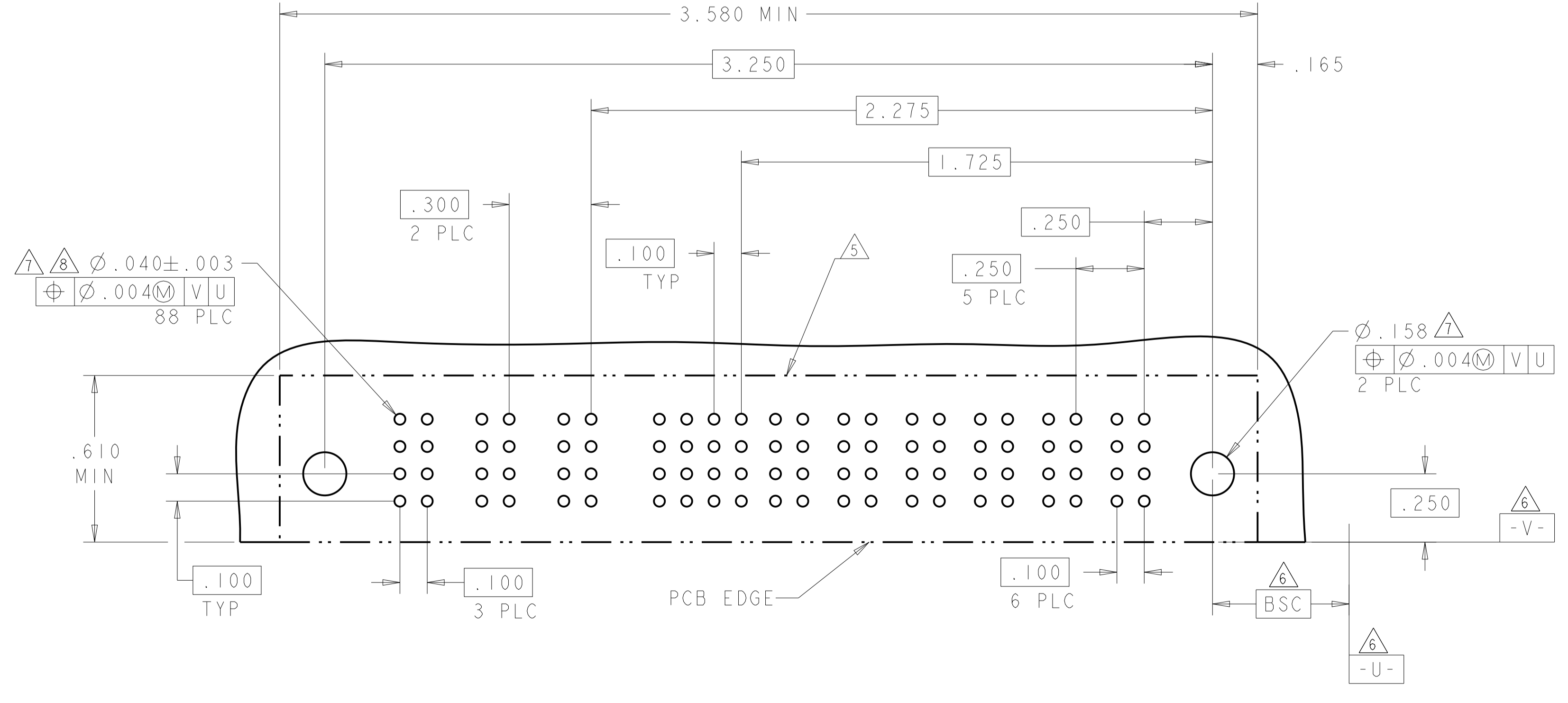

CODE	TAIL LENGTH	DESCRIPTION	CODE	TAIL LENGTH	ROW
RB	.090	MFBL	I	.090	A
RM	.135	STD	H	.135	D
RA	.135	MFBL	G	.135	C
			F	.135	B
			E	.135	A
POWER CONTACT			SIGNAL CONTACT		

THIS DRAWING IS A CONTROLLED DOCUMENT. DWG: R.GRZYBOWSKI, 08APR05; CHK: M.PERCHEK, 08APR05; APVD: M.PERCHEK. NAME: RIGHT ANGLE RECEPTACLE ASSEMBLY WITH GUIDES MULTI-BEAM XL. DIMENSIONS: INCHES. TOLERANCES UNLESS OTHERWISE SPECIFIED: 0 PLC ±.01; 1 PLC ±.01; 2 PLC ±.01; 3 PLC ±.005; 4 PLC ±.002; ANGLES ±.020. MATERIAL: FINISH: WEIGHT: 114-13038. CUSTOMER DRAWING. SCALE: 4:1. SHEET: 2 OF 6. REV: H5.

REVISIONS				
P. LTR.	DESCRIPTION	DATE	OWN	APVD
-	SEE SHEET 1	-	-	-

PART NUMBER	ROWS	POWER							SIGNAL		POWER		
		P10	P9	P8	P7	P6	P5	P4	2	1	P3	P2	P1
1-6450360-0	D C B A	RM	RM	RM	RM	RM	RM	RM	H	H	RM	RM	RM
									G	G			
									F	F			
									E	E			

PART NUMBER	ROWS	POWER				SIGNAL					POWER		
		P6	P5	P4	P3	6	5	4	3	2	1	P2	P1
1-6450360-1	D C B A	RM	RM	RM	RM	H	H	H	H	H	H	RM	RM
						G	G	G	G	G	G		
						F	F	F	F	F	F		
						E	E	E	E	E	E		

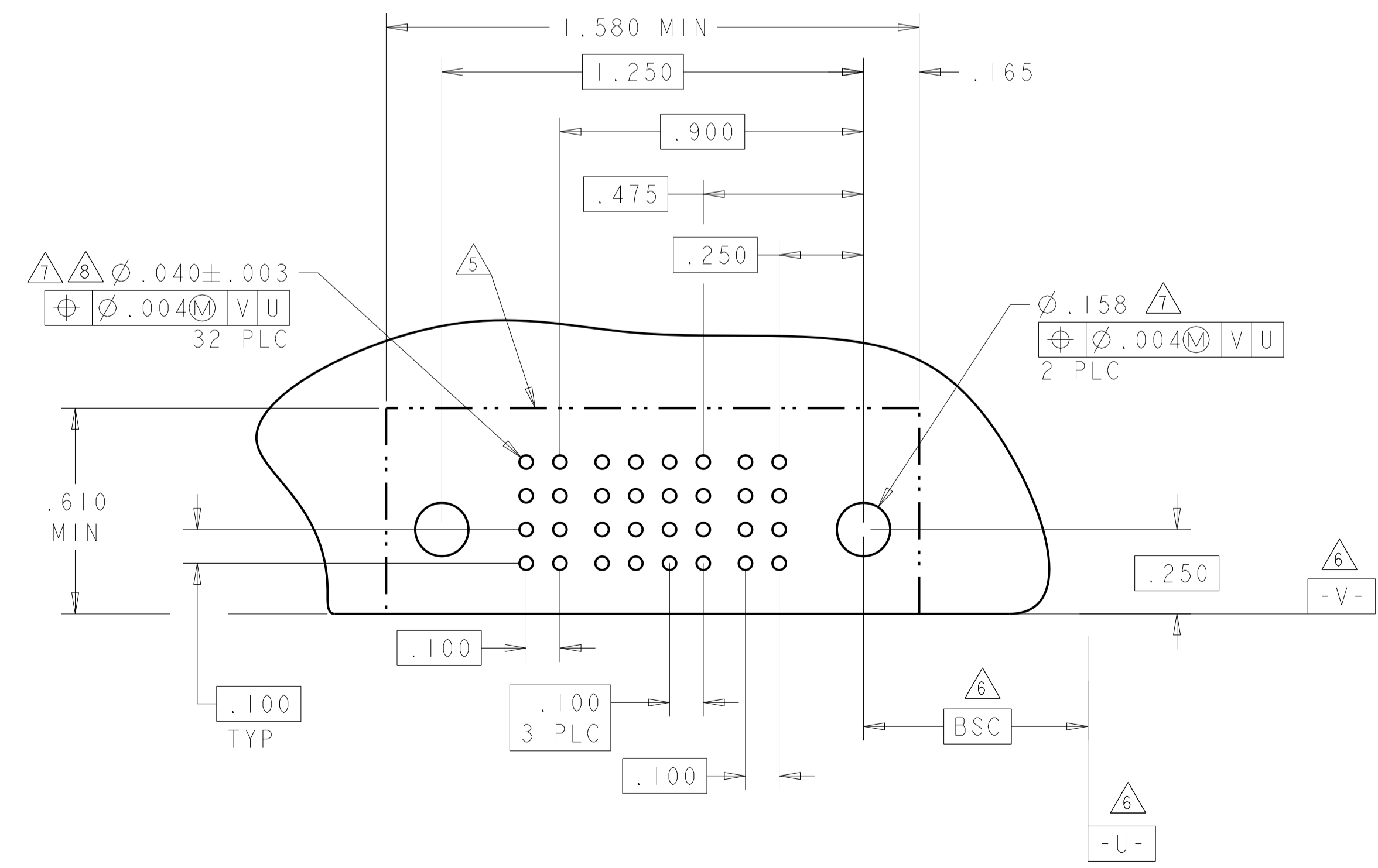
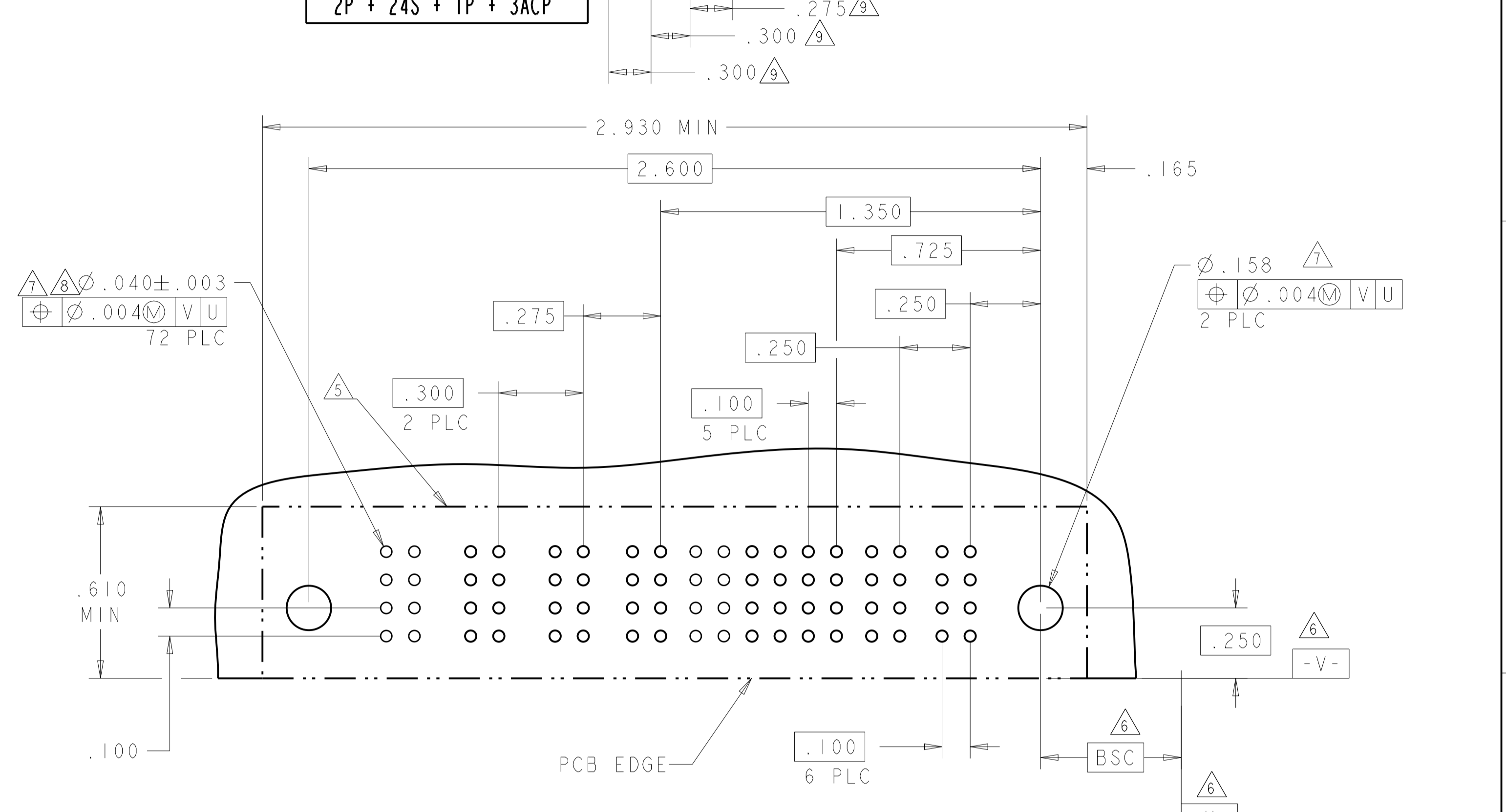
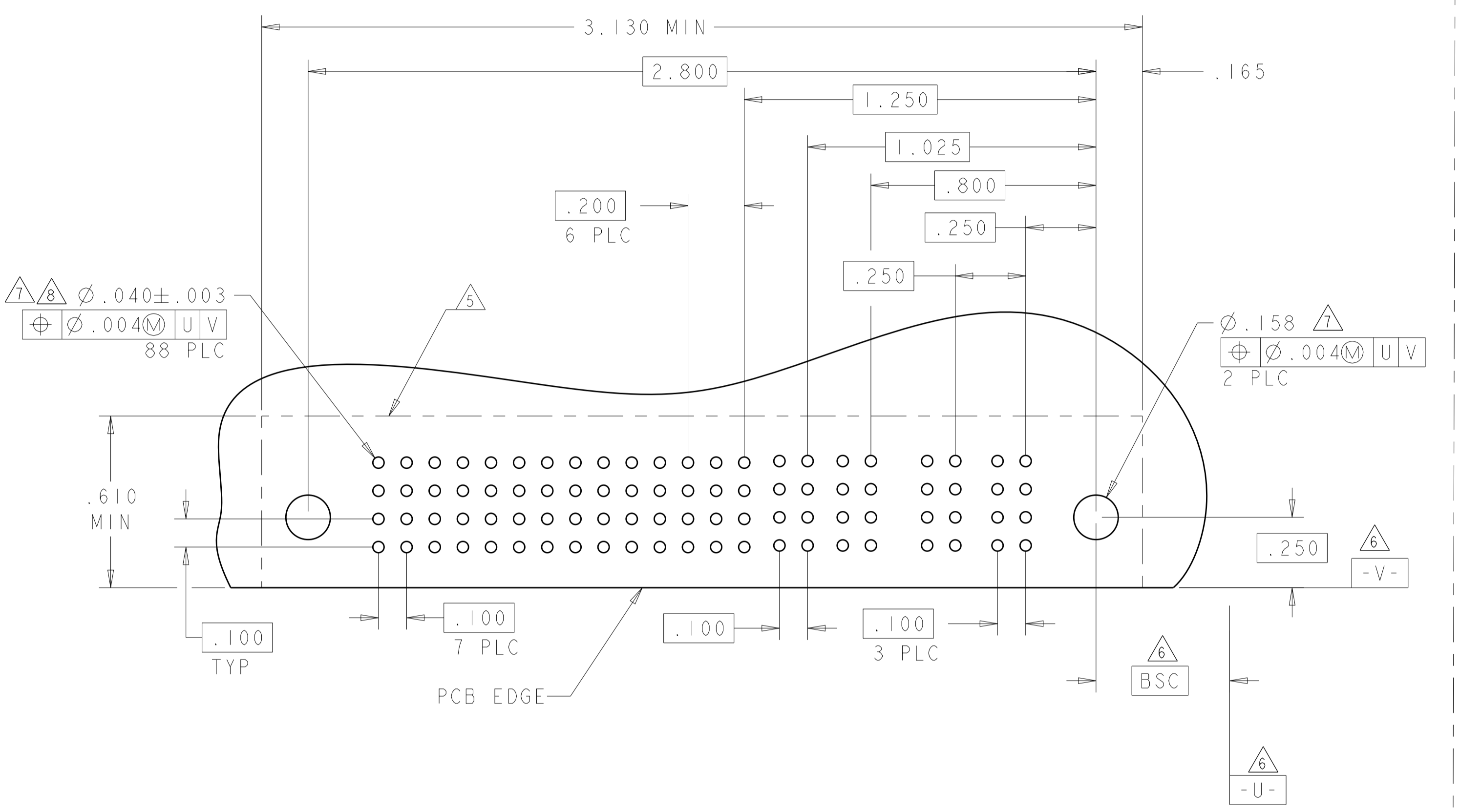

PART NUMBER	ROWS	POWER		SIGNAL				POWER	
		P2	P1	4	3	2	1	P1	P2
1-6450360-2	D C B A	RA	RA	H	H	H	H	RA	RA
				G	G	G	G		
				F	F	F	F		
				E	E	E	E		

THIS DRAWING IS A CONTROLLED DOCUMENT. OWN: R. GRZYBOWSKI, DBAPROS; CHK: M. PERCHERKE, DBAPROS; APVD: M. PERCHERKE.

DIMENSIONS: INCHES. TOLERANCES UNLESS OTHERWISE SPECIFIED: 0 PLC ±.01, 1 PLC ±.01, 2 PLC ±.01, 3 PLC ±.005, 4 PLC ±.002, ANGLES ±.020.

MATERIAL: FINISH:

PRODUCT SPEC: 108-1973  
 APPLICATION SPEC: 114-13038  
 WEIGHT: CUSTOMER DRAWING

NAME: RIGHT ANGLE RECEPTACLE ASSEMBLY WITH GUIDES MULTI-BEAM XL  
 SIZE: A1  
 CAGE CODE: 100779  
 DRAWING NO: 6450360

SCALE: 4:1 SHEET 3 OF 6 REV: H5

REVISIONS				
P.	LTN	DESCRIPTION	DATE	APVD
-	-	SEE SHEET 1	-	-

PART NUMBER	ROWS	POWER		SIGNAL												POWER	
		P4	P3	12	11	10	9	8	7	6	5	4	3	2	1	P2	P1
1-6450360-3	D	RM	RM	H	H	H	H	H	H	H	H	H	H	H	H	RM	RM
	C			G	G	G	G	G	G	G	G	G	G	G			
	B			F	F	F	F	F	F	F	F	F	F	F	F		
	A			E	E	E	E	E	E	E	E	E	E	E	E		

2P + 48S + 2P

PART NUMBER	ROWS	POWER		SIGNAL				POWER	
		P4	P3	4	3	2	1	P2	P1
1-6450360-4	D	RM	RM	H	H	H	H	RM	RM
	C			G	G	G	G		
	B			F	F	F	F		
	A			E	E	E	E		

2P + 16S + 2P

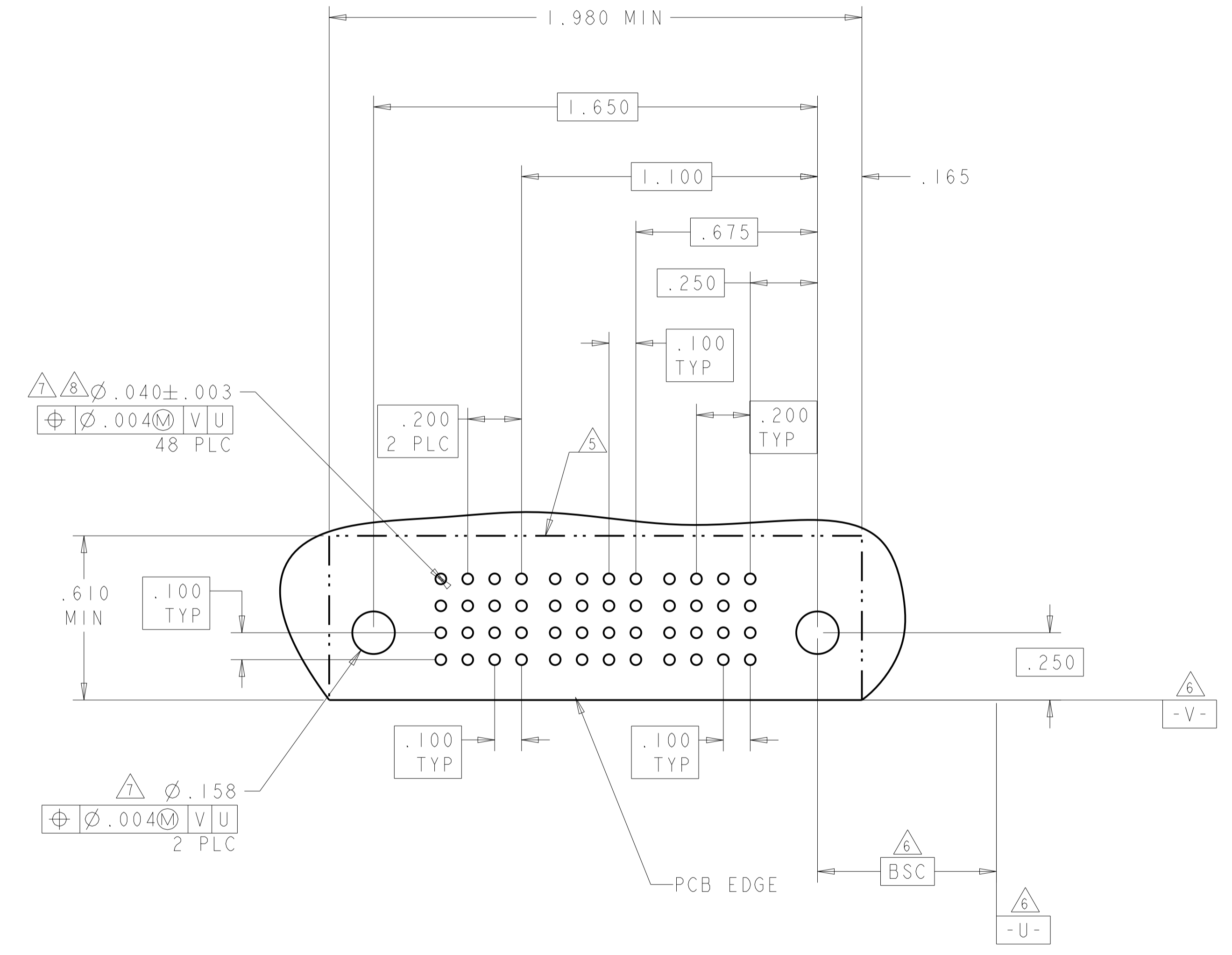
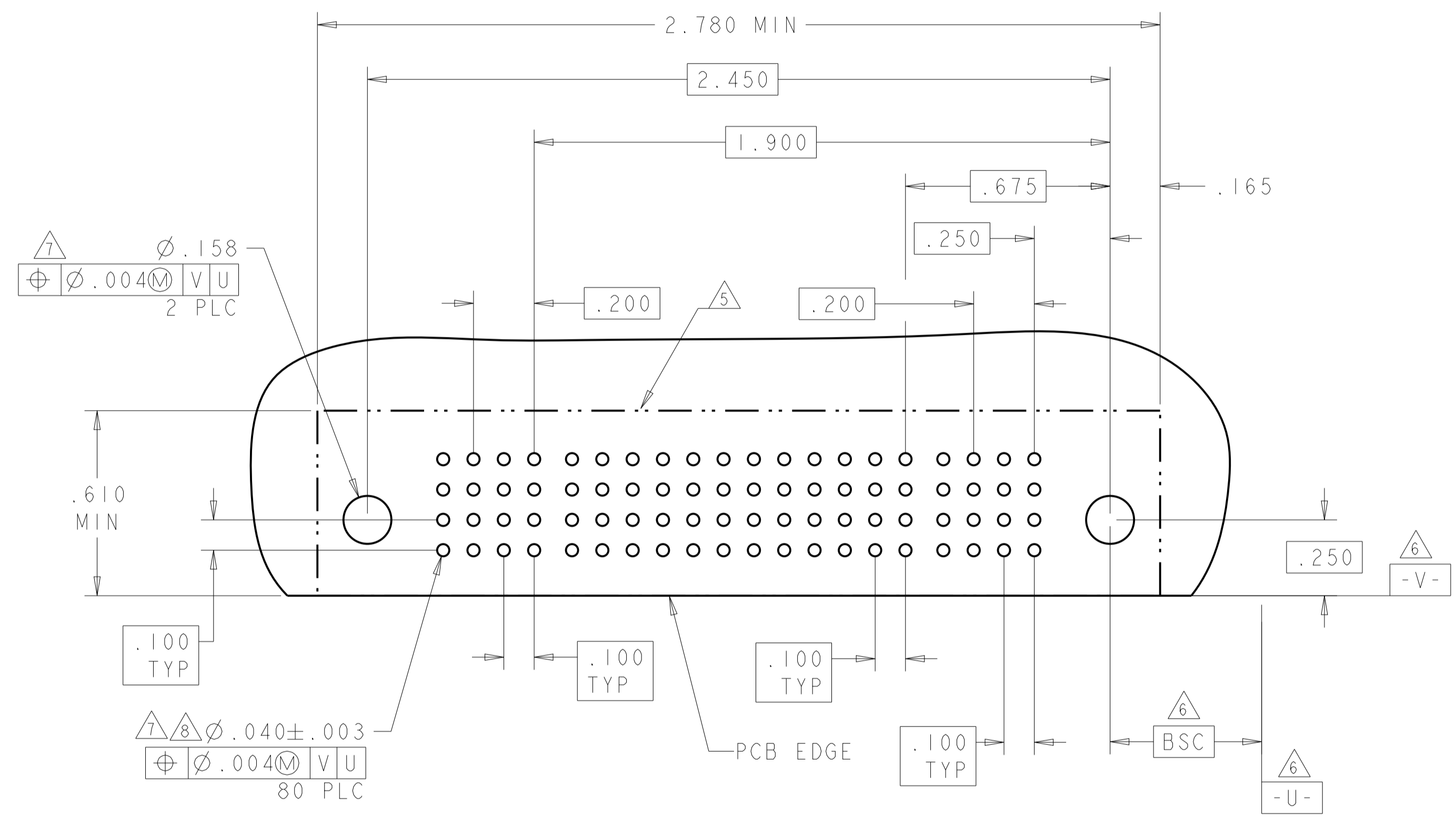

THIS DRAWING IS A CONTROLLED DOCUMENT.

DIMENSIONS:	TOLERANCES UNLESS OTHERWISE SPECIFIED:	OWN: R. GRZYBOWSKI / 08APROS	CHK: M. PERCHERKE / 08APROS	APVD: M. PERCHERKE	NAME: RIGHT ANGLE RECEPTACLE ASSEMBLY WITH GUIDES MULTI-BEAM XL
INCHES	0 PLC ±.01 2 PLC ±.01 3 PLC ±.005 4 PLC ±.002	PRODUCT SPEC: 108-1973	APPLICATION SPEC: 114-13038	SIZE: A1	CAGE CODE: 6450360
MATERIAL:	FINISH:	WEIGHT:	CUSTOMER DRAWING	SCALE: 4:1	SHEET 4 OF 6

4805 (3/13)

REVISIONS				
P.	LTN.	DESCRIPTION	DATE	APP'D.
-	-	SEE SHEET 1	-	-

PART NUMBER	ROWS	POWER		SIGNAL			POWER	
		P4	P3	3	2	1	P2	P1
6450360-7	D C B A	RA	RA	H	H	H	RA	RA
				G	G	G		
				F	F	F		
				E	E	E		
2P + 12S + 2P								

PART NUMBER	ROWS	POWER		SIGNAL										POWER					
		P6	P5	11	10	9	8	7	6	5	4	3	2	1	P5	P4	P3	P2	P1
1-6450360-5	D C B A	RM	RM	H	H	H	H	H	H	H	H	H	H	H	RM	RM	RM	RM	
				G	G	G													
				F	F	F	F	F	F	F	F	F	F	F					F
				E	E	E	E	E	E	E	E	E	E	E					E
5P + 44S + 1P																			

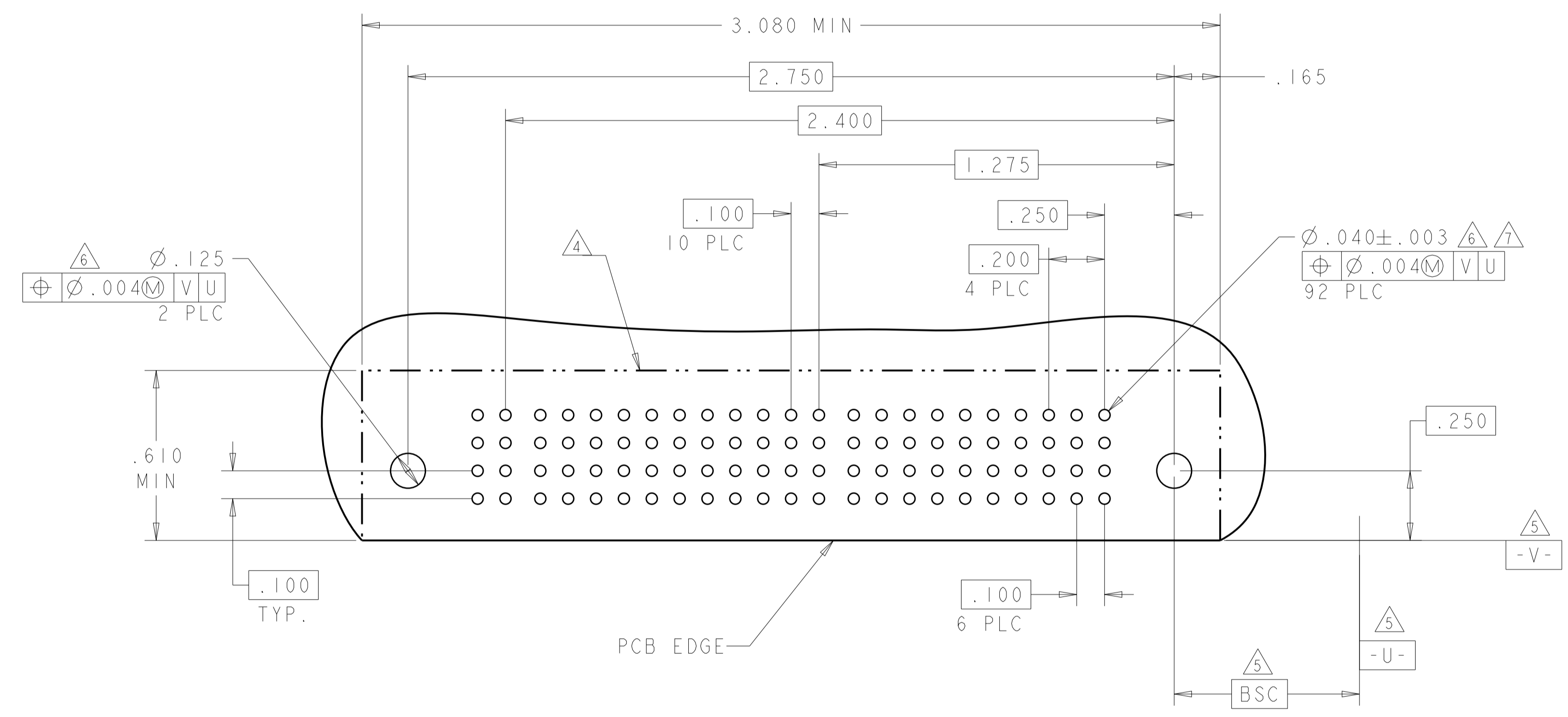
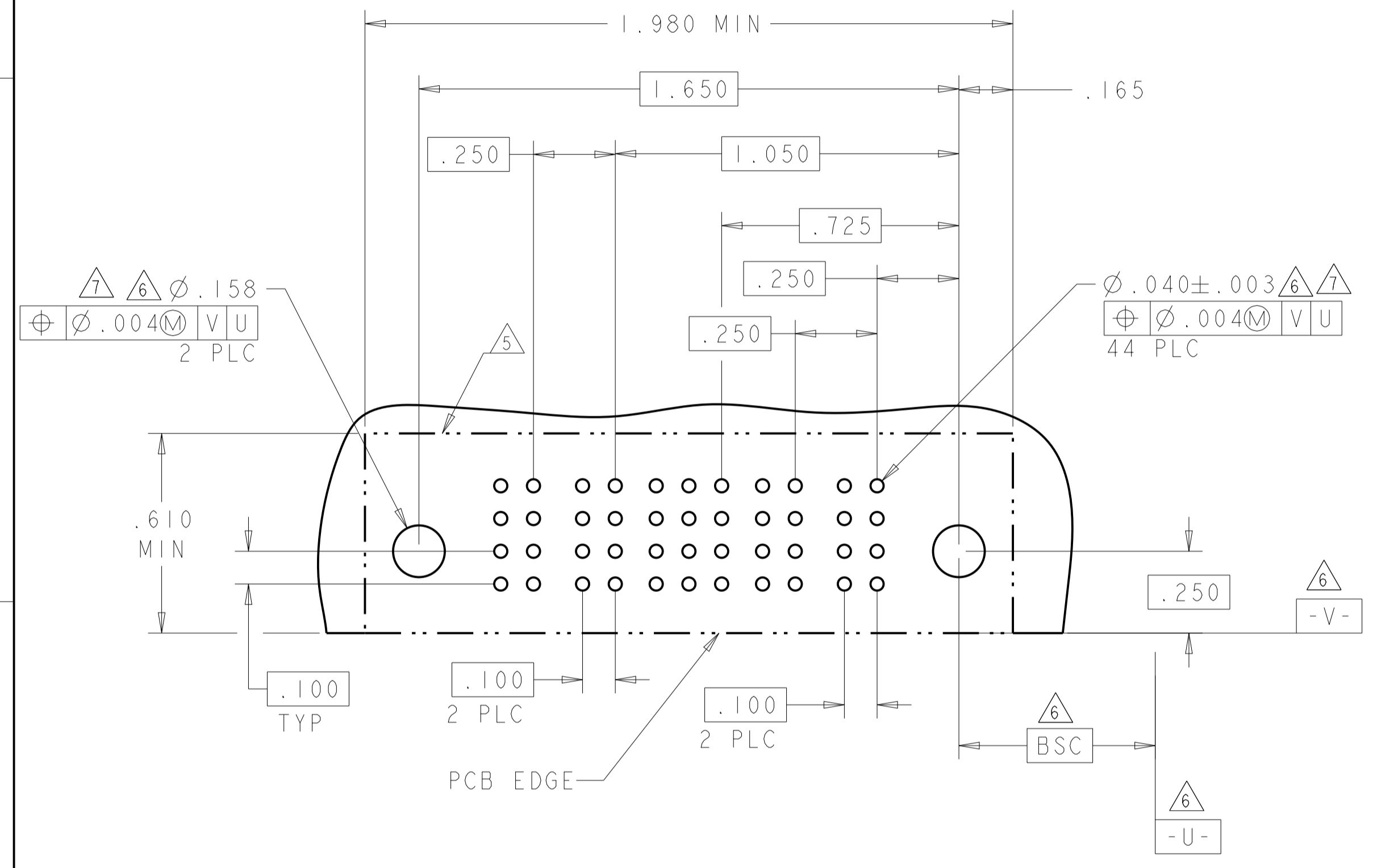

THIS DRAWING IS A CONTROLLED DOCUMENT.		OWN: R. GRZYBOWSKI / 08APROS	 TE Connectivity
DIMENSIONS: INCHES		CHK: M. PERCHERKE / 08APROS	
TOLERANCES UNLESS OTHERWISE SPECIFIED:		APVD: M. PERCHERKE	NAME: RIGHT ANGLE RECEPTACLE ASSEMBLY WITH GUIDES MULTI-BEAM XL
0 PLC ± .01	1 PLC ± .01	PRODUCT SPEC: 108-1973	SIZE: A1
2 PLC ± .01	3 PLC ± .005	APPLICATION SPEC: 114-13038	CAGE CODE: 6450360
4 PLC ± .0020	ANGLES ± .020	WEIGHT: -	RESTRICTED TO: -
MATERIAL: -	FINISH: -	CUSTOMER DRAWING	SCALE: 4:1
SHEET 5 OF 6			REV: H5

REVISIONS				
P.	LTN.	DESCRIPTION	DATE	APVD.
-	-	SEE SHEET 1	-	-

PART NUMBER	ROWS	SIGNAL														POWER			
		P5	12	11	10	9	8	7	6	5	4	3	2	1	P4	P3	P2	P1	
1-6450360-6	D	RM	H		H	H	H		H	H		H			RM	RM	RM	RM	
	C		G		G	G	G		G	G	G	G							
	B		F		F	F	F		F		F		F						
	A		E		E	E	E	E	E	E	E	E	E	E					

4P + 48S + 1P

BLANK SIGNAL PINS ARE UNLOADED

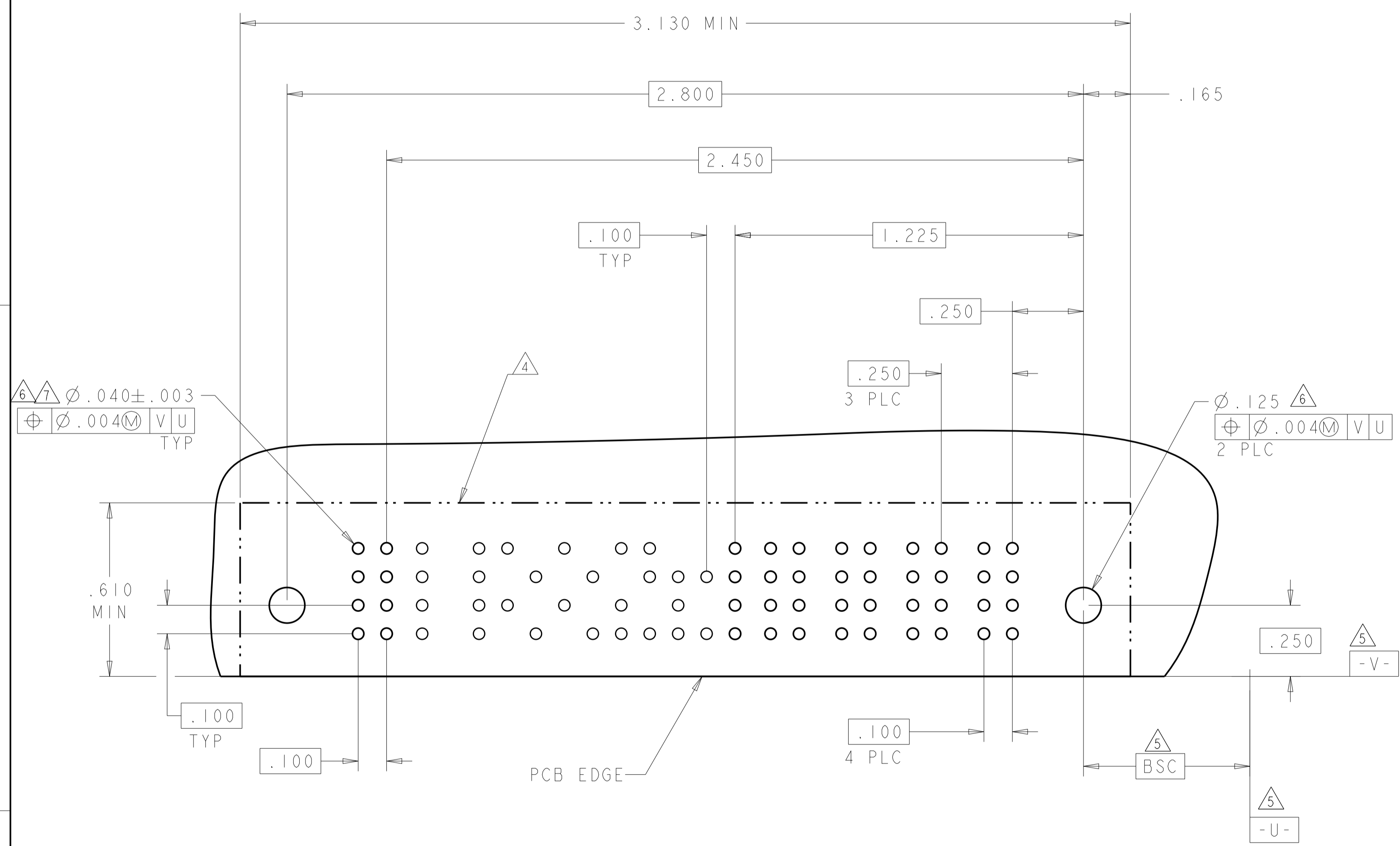

THIS DRAWING IS A CONTROLLED DOCUMENT.		OWN: R. GRZYBOWSKI 08APROS	 TE Connectivity
DIMENSIONS: INCHES		CHK: M. PERCHERKE 08APROS	
TOLERANCES UNLESS OTHERWISE SPECIFIED: 0 PLC ±. 1 PLC ±.01 2 PLC ±.01 3 PLC ±.005 4 PLC ±.0020 ANGLES ±.2°		APVD: M. PERCHERKE	NAME: RIGHT ANGLE RECEPTACLE ASSEMBLY WITH GUIDES MULTI-BEAM XL
MATERIAL: -		PRODUCT SPEC: 108-1973	SIZE: A1
FINISH: -		APPLICATION SPEC: 114-13038	CAGE CODE: 6450360
CUSTOMER DRAWING		WEIGHT: -	RESTRICTED TO: -
SCALE: 4:1		SHEET: 6 OF 6	REV: H5