

# FEATURES SELECTION GUIDE

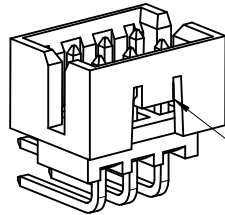

② CENTER LOCK

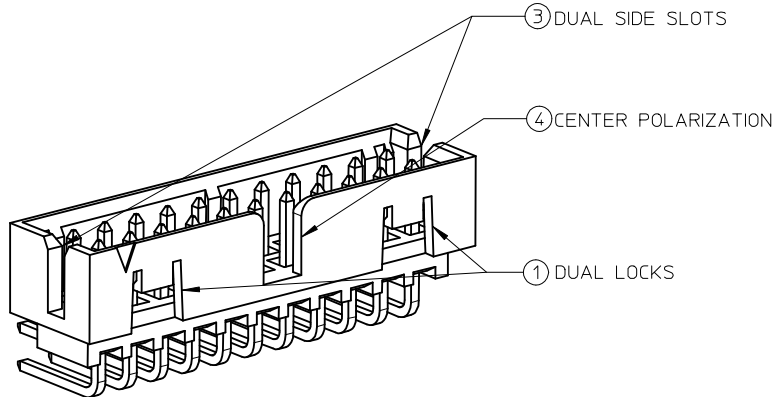

① DUAL LOCKS

③ DUAL SIDE SLOTS

④ CENTER POLARIZATION

CIRCUIT SIZE	FEATURES				SHEET NO
	FRICTION LOCKS		③ DUAL SIDE SLOTS	④ CENTER POLARIZATION	
	① DUAL	② CENTER			
4 - 6	N.A	N.A	YES	N.A	2 - 3
	N.A	YES	YES	N.A	
8 TO 12	N.A	N.A	YES	YES	4 - 5
	N.A	YES	YES	N.A	
14 TO 50	YES	N.A	YES	YES	6 - 9
	N.A	N.A	YES	YES	

PACKAGING SPECIFICATION TABLE

TAPE AND REEL PACKAGING	PK-87831-300
TUBE STANDARD PACKAGING	PK-87831-001
TUBE NON-STANDARD PACKAGING FOR: 87833-0861 87833-1420	PK-87831-002

<b>SEE SHEET 7&amp;9</b> EC NO: S2017-0353 DRWNG: GEMARLY 2016/10/19 CH'KD: SCHEONG 2016/12/30 APPR: KHLIM 2016/12/30	QUALITY SYMBOLS	GENERAL TOLERANCES (UNLESS SPECIFIED)		DIMENSION STYLE <b>MM ONLY</b>		SCALE <b>NTS</b>	DESIGN UNITS <b>METRIC</b>	THIRD ANGLE PROJECTION	
	$\nabla_{\text{A}}=0$ $\nabla_{\text{C}}=0$ $\nabla_{\text{P}}=0$	mm	INCH	DRAWN BY GMENARLY	DATE 2015/09/29	TITLE <b>MILLIGRID, 2MM PITCH SHROUDED HEADER R/A, THROUGH HOLE</b>			
		4 PLACES	± --- ± ---	3 PLACES	± --- ± ---	CHECKED BY CGOH	DATE 2015/10/30		
		2 PLACES	± 0.20 ± ---	1 PLACE	± --- ± ---	APPROVED BY KHLIM	DATE 2015/11/03		
	0 PLACE	± --- ± ---	ANGULAR ± 3 °		MATERIAL NO.	DOCUMENT NO.	SHEET NO.		
	DRAFT WHERE APPLICABLE MUST REMAIN WITHIN DIMENSIONS		SEE TABLE		SD-87833-0001		1 OF 9		
			SIZE A3		THIS DRAWING CONTAINS INFORMATION THAT IS PROPRIETARY TO MOLEX INCORPORATED AND SHOULD NOT BE USED WITHOUT WRITTEN PERMISSION				

4 TO 6 CIRCUITS

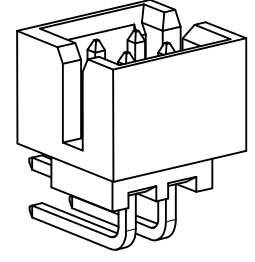
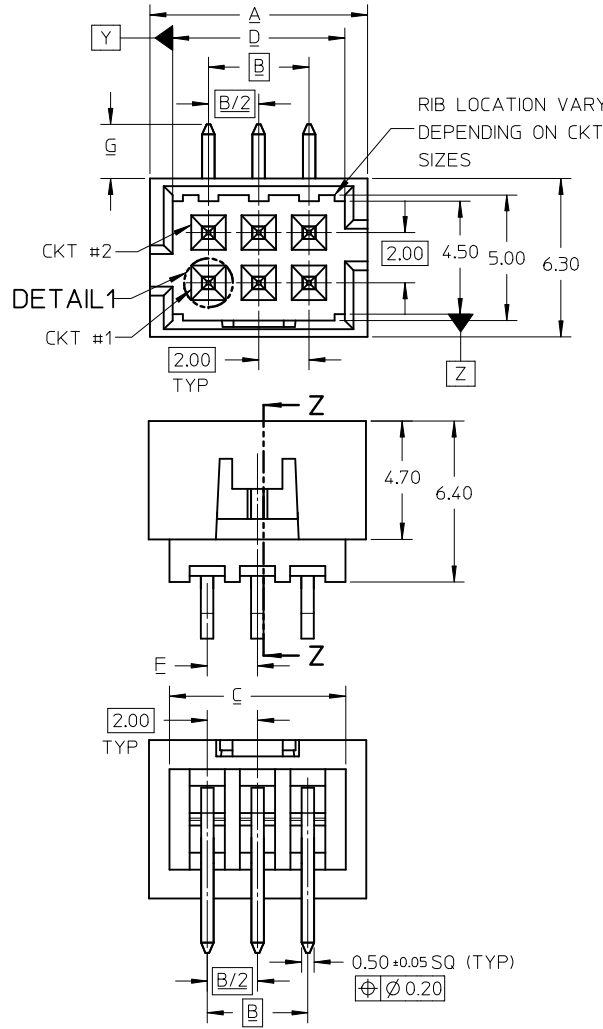

ISO VIEW OF HEADER  
DUAL SIDE SLOTS

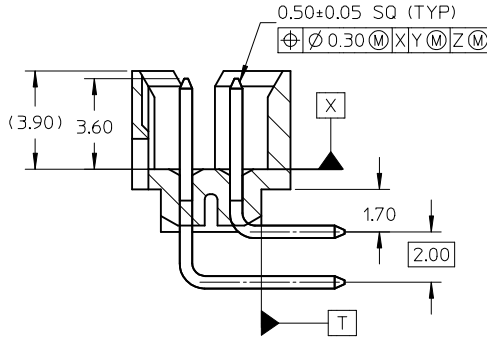

SECTION Z-Z

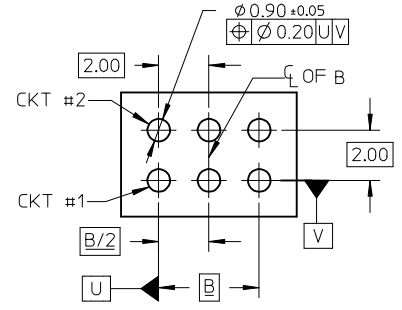
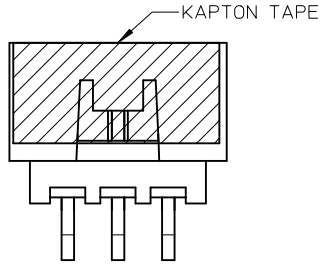

RECOMMENDED PCB LAYOUT

- NOTES:
- MATERIALS:  
HOUSING: 30% GF, NYLON, UL94V-0, COLOR: BLACK  
PIN: 0.50MM SQ PHOSPHOR BRONZE
  - FINISHES: REFER TO PLATING OPTIONS
  - PRODUCT SPECIFICATION: PS-87831-027
  - PACKAGING SPECIFICATION: SEE PACKAGING SPECS TABLE ON SHEET 1
  - MATES WITH: A. MOLEX CRIMP RECEPTACLE HOUSING: 51110 SERIES AND CRIMP TERMINAL: 50394 SERIES  
B. MOLEX 2MM MILLIGRID DUAL ROW IDT: 87568 SERIES  
C. MOLEX 2MM MILLIGRID DUAL ROW RECEPTACLE: 79107 (GOLD PLATED), 78787 (TIN PLATED)
  - FOR ILLUSTRATION PURPOSE, 6 CIRCUITS HEADER IS SHOWN

SEE SHEET 7&9 IEC NO: S2017-0353 DRAWN: GMENARLY 2016/10/19 CHECKED BY: CHYKD:SCHEONG 2016/12/30 APPR: KHL IM 2016/12/30	QUALITY SYMBOLS $\nabla F = 0$ $\nabla E = 0$ $\nabla D = 0$	GENERAL TOLERANCES (UNLESS SPECIFIED)		DIMENSION STYLE MM ONLY		SCALE NTS	DESIGN UNITS METRIC	THIRD ANGLE PROJECTION		
			mm	INCH	DRAWN BY GMENARLY	DATE 2015/09/29	TITLE MILLIGRID, 2MM PITCH SHROUDED HEADER R/A, THROUGH HOLE			
		4 PLACES	$\pm$ ---	$\pm$ ---	CHECKED BY CGOH	DATE 2015/10/30				
		3 PLACES	$\pm$ ---	$\pm$ ---	APPROVED BY KHL IM	DATE 2015/11/03				
2 PLACES	$\pm 0.20$	$\pm$ ---	MATERIAL NO.		DOCUMENT NO.		SHEET NO.			
1 PLACE	$\pm$ ---	$\pm$ ---	SEE TABLE		SD-87833-0001		2 OF 9			
0 PLACE	$\pm$ ---	$\pm$ ---	DRAFT WHERE APPLICABLE MUST REMAIN WITHIN DIMENSIONS		THIS DRAWING CONTAINS INFORMATION THAT IS PROPRIETARY TO MOLEX INCORPORATED AND SHOULD NOT BE USED WITHOUT WRITTEN PERMISSION					
		ANGULAR $\pm 3^\circ$								

4 TO 6 CIRCUITS

F	CKT SIZE	ASSY P/N WITHOUT KAPTON IN TUBE	ASSY P/N WITH KAPTON IN TUBE	ASSY P/N WITH KAPTON IN T&R	PLATING OPTIONS	FRICTION LOCKS		DUAL SIDE SLOTS	CENTER POLARIZATION	DIMENSION						
						DUAL	CENTER			A	B	C	D	E	F	G (SOLDER TAIL)
4	87833-0419	N.A	N.A	1						6.65	2.00	5.00	4.85	N.A	N.A	2.16
	87833-0420	N.A	N.A	2	N.A	N.A	YES	N.A								
	87833-0421	N.A	N.A	3												
	87833-5920	N.A	N.A	2	N.A	N.A	YES	N.A								
	87833-0431	87833-0441	87833-0451	2	N.A	YES	YES	N.A								
	87833-0432	N.A	N.A	3	N.A	YES	YES	N.A								
87833-0461	N.A	N.A	2	N.A	YES	YES	N.A									
6	87833-0619	N.A	N.A	1						8.65	4.00	7.00	6.85	N.A	N.A	2.16
	87833-0620	N.A	N.A	2	N.A	N.A	YES	N.A								
	87833-0621	N.A	N.A	3												
	87833-6420	N.A	N.A	2	N.A	N.A	YES	N.A								
	87833-0631	87833-0641	87833-0651	2	N.A	YES	YES	N.A								
	87833-0632	N.A	N.A	3	N.A	YES	YES	N.A								
	87833-0661	N.A	N.A	2	N.A	YES	YES	N.A								
	87833-0624	N.A	N.A	2	N.A	N.A	YES	N.A								
87833-0625	N.A	N.A	3													

PLATING OPTIONS:

- 1 - 0.05-0.13um/2-5uin GOLD IN CONTACT AREA AND 1.88um/75uin MIN. MATTE TIN IN SOLDER TAIL AREA OVER 1.27um/50uin MIN. NICKEL OVERALL.
- 2 - 0.38um/15uin MIN. GOLD IN CONTACT AREA AND 1.88um/75uin MIN. MATTE TIN IN SOLDER TAIL AREA OVER 1.27um/50uin MIN. NICKEL OVERALL.
- 3 - 0.76um/30uin MIN. GOLD IN CONTACT AREA AND 1.88um/75uin MIN. MATTE TIN IN SOLDER TAIL AREA OVER 1.27um/50uin MIN. NICKEL OVERALL.

SEE SHEET 789 EC NO: S2017-0353 DRWN:GMENARLY 2016/10/19 CHKD:SCHEONG 2016/12/30 APPR:KHLIM 2016/12/30	DESCRIPTION	QUALITY SYMBOLS	GENERAL TOLERANCES (UNLESS SPECIFIED)		DIMENSION STYLE		SCALE	DESIGN UNITS	THIRD ANGLE PROJECTION			
			mm	INCH	MM ONLY		NTS	METRIC				
		$\nabla_A=0$	4 PLACES	± ---	± ---	DRAWN BY	DATE	TITLE				
		$\nabla_C=0$	3 PLACES	± ---	± ---	GMENARLY	2015/09/29	MILLIGRID, 2MM PITCH SHROUDED HEADER R/A, THROUGH HOLE				
$\nabla_P=0$	2 PLACES	± 0.20	± ---	CHECKED BY	DATE							
	1 PLACE	± ---	± ---	CGOH	2015/10/30	molex						
	0 PLACE	± ---	± ---	APPROVED BY	DATE							
		ANGULAR ± 3 °		KHLIM	2015/11/03	MATERIAL NO.		DOCUMENT NO.	SHEET NO.			
		DRAFT WHERE APPLICABLE MUST REMAIN WITHIN DIMENSIONS		SEE TABLE		SD-87833-0001		3 OF 9				
A5	REV			SIZE		THIS DRAWING CONTAINS INFORMATION THAT IS PROPRIETARY TO MOLEX INCORPORATED AND SHOULD NOT BE USED WITHOUT WRITTEN PERMISSION						
				A3								

8 TO 12 CIRCUITS

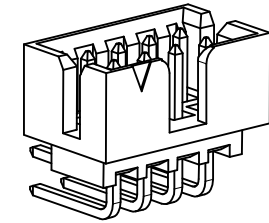
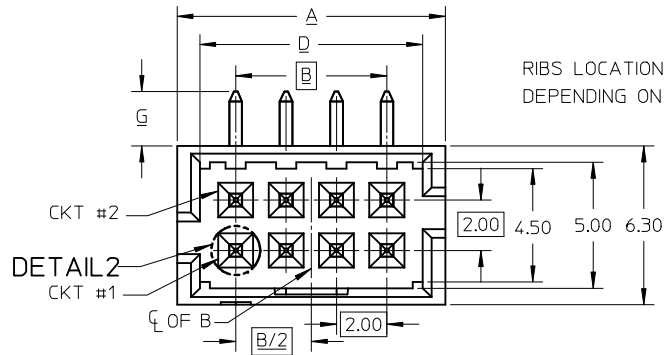

ISO VIEW OF HEADER WITH CENTER POLARIZATION AND DUAL SIDE SLOTS

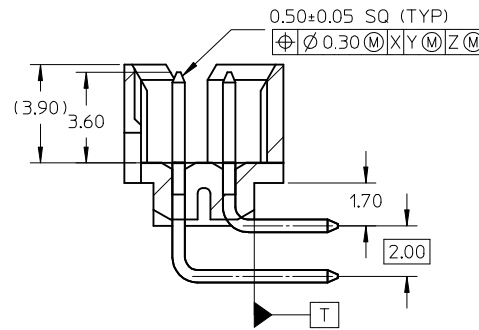
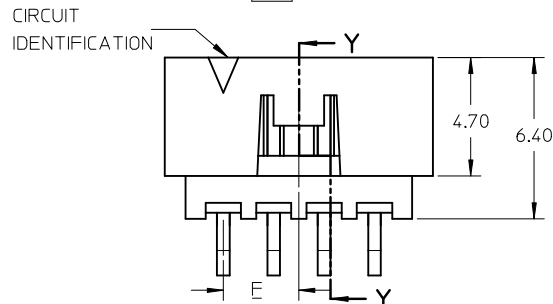

SECTION Y-Y

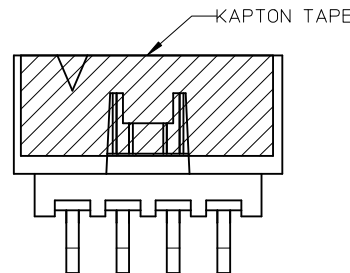
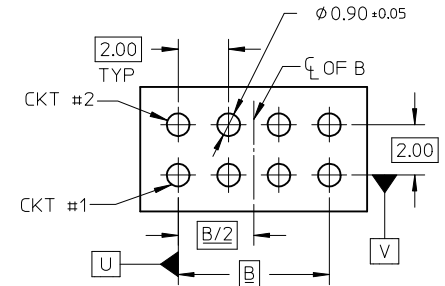

NOTES:

- MATERIALS:  
HOUSING: 30% GF, NYLON, UL94V-0, COLOR: BLACK  
PIN: 0.50MM SQ PHOSPHOR BRONZE
- FINISHES: REFER TO PLATING OPTIONS
- PRODUCT SPECIFICATION: PS-87831-027
- PACKAGING SPECIFICATION: SEE PACKAGING SPECS TABLE ON SHEET 1
- MATES WITH: A. MOLEX CRIMP RECEPTACLE HOUSING: 51110 SERIES AND CRIMP TERMINAL: 50394 SERIES  
B. MOLEX 2MM MILLIGRID DUAL ROW IDT: 87568 SERIES  
C. MOLEX 2MM MILLIGRID DUAL ROW RECEPTACLE: 79107 (GOLD PLATED), 78787 (TIN PLATED)
- FOR ILLUSTRATION PURPOSE, 8 CIRCUIT HEADER IS SHOWN

SEE SHEET 789 EC NO: S2017-0353 DRWN:GMENARLY 2016/10/19 CHKD:SCHEONG 2016/12/30 APPR:KHLIM 2016/12/30	QUALITY SYMBOLS $\nabla_A=0$ $\nabla_E=0$ $\nabla_F=0$	GENERAL TOLERANCES (UNLESS SPECIFIED)		DIMENSION STYLE MM ONLY		SCALE NTS	DESIGN UNITS METRIC	THIRD ANGLE PROJECTION			
		mm	INCH	DRAWN BY GMENARLY	DATE 2015/09/29	TITLE MILLIGRID, 2MM PITCH SHROUDED HEADER R/A, THROUGH HOLE					
		4 PLACES	$\pm$ ---	$\pm$ ---	CHECKED BY CGOH	DATE 2015/10/30	DOCUMENT NO. SD-87833-0001				
		3 PLACES	$\pm$ ---	$\pm$ ---	APPROVED BY KHLIM	DATE 2015/11/03					
2 PLACES	$\pm 0.20$	$\pm$ ---	MATERIAL NO.		SHEET NO. 4 OF 9						
1 PLACE	$\pm$ ---	$\pm$ ---	SEE TABLE		THIS DRAWING CONTAINS INFORMATION THAT IS PROPRIETARY TO MOLEX INCORPORATED AND SHOULD NOT BE USED WITHOUT WRITTEN PERMISSION						
0 PLACE	$\pm$ ---	$\pm$ ---	ANGULAR $\pm 3^\circ$								
DRAFT WHERE APPLICABLE MUST REMAIN WITHIN DIMENSIONS				SIZE A3							

8 TO 12 CIRCUITS

CKT SIZE	ASSY P/N WITHOUT KAPTON IN TUBE	ASSY P/N WITH KAPTON IN TUBE	ASSY P/N WITH KAPTON IN T&R	PLATING OPTIONS	FRICTION LOCKS		DUAL SIDE SLOTS	CENTER POLARIZATION	DIMENSION						
					DUAL	CENTER			A	B	C	D	E	F	G (SOLDER TAIL)
8	87833-0819	N.A	N.A	1					10.65	6.00	9.00	8.85	N.A	N.A	2.16
	87833-0820	N.A	N.A	2	N.A	N.A	YES	YES							
	87833-0821	N.A	N.A	3											
	87833-6320	N.A	N.A	2	N.A	N.A	YES	YES							
	87833-6321	N.A	N.A	3											
	87833-0831	87833-0841	87833-0851	2	N.A	YES	YES	N.A							
	87833-0832	N.A	N.A	3											
	87833-0861	N.A	N.A	2	N.A	YES	YES	N.A							
10	87833-0824	N.A	N.A	2	N.A	N.A	YES	YES	12.65	8.00	11.00	10.85	N.A	4.00	2.16
	87833-0825	N.A	N.A	3											
	87832-1019	N.A	N.A	1											
	87833-1020	N.A	N.A	2	N.A	N.A	YES	YES							
	87833-1021	N.A	N.A	3											
	87833-1031	N.A	N.A	2	N.A	YES	YES	N.A							
	87833-1032	N.A	N.A	3											
	N.A	87833-1041	87833-1051	2	N.A	YES	YES	N.A							
12	87833-1024	N.A	N.A	2	N.A	N.A	YES	YES	14.65	10.00	13.00	12.85	N.A	5.00	2.16
	87833-1025	N.A	N.A	3											
	87833-1219	N.A	N.A	1											
	87833-1220	N.A	N.A	2	N.A	N.A	YES	YES							
	87833-1221	N.A	N.A	3											
	87833-6020	N.A	N.A	2	N.A	N.A	YES	YES							
	87833-1231	N.A	N.A	2	N.A	YES	YES	N.A							
	87833-1232	N.A	N.A	3											
87833-1224	N.A	N.A	2	N.A	N.A	YES	YES	N.A	N.A	2.92					
87833-1225	N.A	N.A	3												

PLATING OPTIONS:

- 1 - 0.05-0.13um/2-5uin GOLD IN CONTACT AREA AND 1.88um/75uin MIN. MATTE TIN IN SOLDER TAIL AREA OVER 1.27um/50uin MIN. NICKEL OVERALL.
- 2 - 0.38um/15uin MIN. GOLD IN CONTACT AREA AND 1.88um/75uin MIN. MATTE TIN IN SOLDER TAIL AREA OVER 1.27um/50uin MIN. NICKEL OVERALL.
- 3 - 0.76um/30uin MIN. GOLD IN CONTACT AREA AND 1.88um/75uin MIN. MATTE TIN IN SOLDER TAIL AREA OVER 1.27um/50uin MIN. NICKEL OVERALL.

SEE SHEET 7&9 EC NO: S2017-0353 DRAWN: GEMARLY 2016/10/19 CHK'D: SCHEONG 2016/12/30 APPR: KHL IM 2016/12/30	QUALITY SYMBOLS FA=0 FG=0 FP=0	GENERAL TOLERANCES (UNLESS SPECIFIED)		DIMENSION STYLE MM ONLY		SCALE NTS	DESIGN UNITS METRIC	THIRD ANGLE PROJECTION	
			mm	INCH	DRAWN BY GMENARLY	DATE 2015/09/29	TITLE MILLIGRID, 2MM PITCH SHROUDED HEADER R/A, THROUGH HOLE		
		4 PLACES	± ---	± ---	CHECKED BY CGOH	DATE 2015/10/30	<b>molex</b>		
		3 PLACES	± ---	± ---	APPROVED BY KHL IM	DATE 2015/11/03			
		2 PLACES	± 0.20	± ---	MATERIAL NO.		DOCUMENT NO.	SHEET NO.	
1 PLACE	± ---	± ---	SEE TABLE		SD-87833-0001	5 OF 9			
0 PLACE	± ---	± ---	ANGULAR ± 3 °		THIS DRAWING CONTAINS INFORMATION THAT IS PROPRIETARY TO MOLEX INCORPORATED AND SHOULD NOT BE USED WITHOUT WRITTEN PERMISSION				
DRAFT WHERE APPLICABLE MUST REMAIN WITHIN DIMENSIONS									

14 TO 50 CIRCUITS

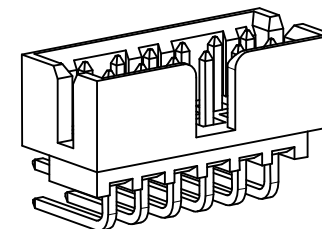
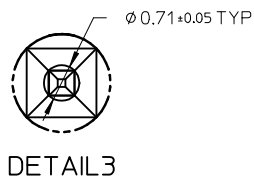
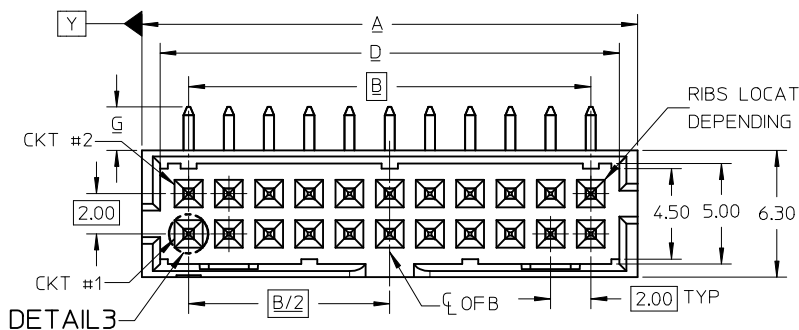

ISO VIEW OF HEADER WITH CENTER POLARIZATION AND DUAL SIDE SLOTS

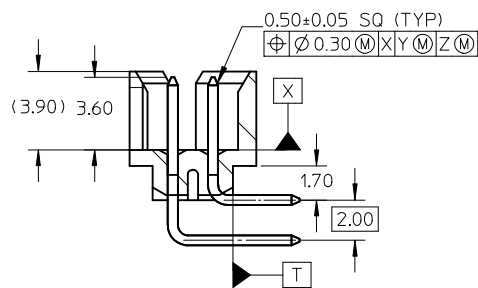
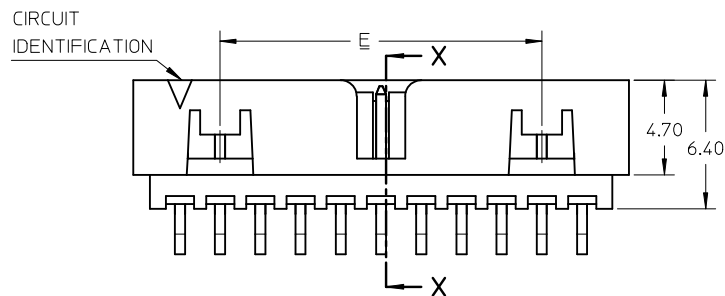

SECTION X-X

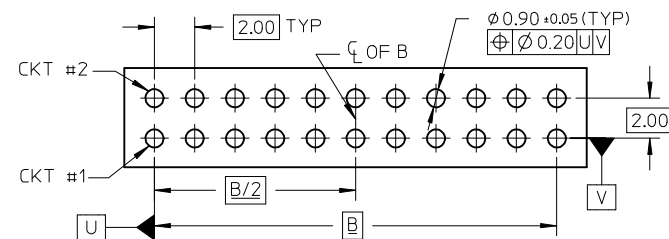
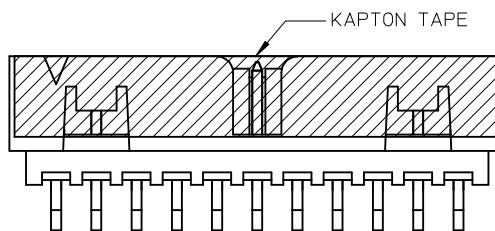
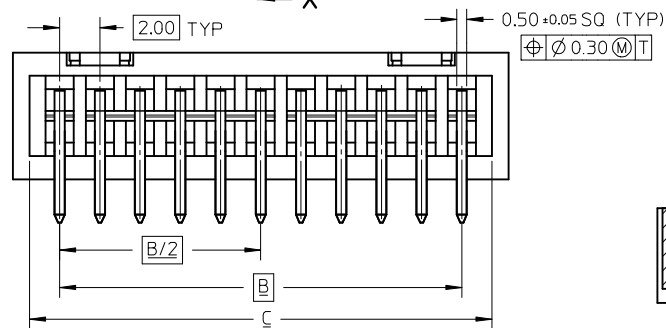

NOTES:

- MATERIALS:  
HOUSING: 30% GF, NYLON, UL94V-0, COLOR: BLACK  
PIN: 0.50MM SQ PHOSPHOR BRONZE
- FINISHES: REFER TO PLATING OPTIONS
- PRODUCT SPECIFICATION: PS-87831-027
- PACKAGING SPECIFICATION: SEE PACKAGING SPECS TABLE ON SHEET 1
- MATES WITH:  
A. MOLEX CRIMP RECEPTACLE HOUSING: 51110 SERIES AND CRIMP TERMINAL: 50394 SERIES  
B. MOLEX 2MM MILLIGRID DUAL ROW IDT: 87568 SERIES  
C. MOLEX 2MM MILLIGRID DUAL ROW RECEPTACLE: 79107 (GOLD PLATED), 78787 (TIN PLATED)
- FOR ILLUSTRATION PURPOSE, 22 CIRCUITS HEADER IS SHOWN

SEE SHEET 7&9 EC NO: S2017-0353 DRWN:GMENARLY 2016/10/19 CHKD:SCHEONG 2016/12/30 APPR:KHL IM 2016/12/30	DESCRIPTION	QUALITY SYMBOLS	GENERAL TOLERANCES (UNLESS SPECIFIED)		DIMENSION STYLE		SCALE	DESIGN UNITS	THIRD ANGLE PROJECTION		
			mm	INCH	MM ONLY		NTS	METRIC			
		$\nabla_A = 0$	4 PLACES ± --- ± ---	mm	INCH	DRAWN BY	DATE	TITLE			
		$\nabla_C = 0$	3 PLACES ± --- ± ---			CHECKED BY	DATE	MILLIGRID, 2MM PITCH SHROUDED HEADER R/A, THROUGH HOLE			
	$\nabla_F = 0$	2 PLACES ± 0.20 ± ---				APPROVED BY					
		1 PLACE ± --- ± ---				DATE					
		0 PLACE ± --- ± ---				KHL IM 2015/11/03					
		ANGULAR ± 3 °		MATERIAL NO.		DOCUMENT NO.		SHEET NO.			
		DRAFT WHERE APPLICABLE MUST REMAIN WITHIN DIMENSIONS		SEE TABLE		SD-87833-0001		6 OF 9			
				SIZE A3		THIS DRAWING CONTAINS INFORMATION THAT IS PROPRIETARY TO MOLEX INCORPORATED AND SHOULD NOT BE USED WITHOUT WRITTEN PERMISSION					

14 TO 24 CIRCUITS

CKT SIZE	ASSY P/N WITHOUT KAPTON IN TUBE	ASSY P/N WITH KAPTON IN TUBE	ASSY P/N WITH KAPTON IN T&R	PLATING OPTIONS	FRICTION LOCKS		DUAL SIDE SLOTS	CENTER POLARIZATION	DIMENSION																
					DUAL	CENTER			A	B	C	D	E	F	G (SOLDER TAIL)										
14	87833-1419	N.A	N.A	1	YES	N.A	YES	YES	16.65	12.00	15.00	14.85	8.00	N.A	2.16										
	87833-1420	N.A	N.A	2											3.18										
	87833-1421	N.A	N.A	3											3.50										
	87833-5320	N.A	N.A	2	YES	N.A	YES	YES							1.70										
	87833-5321	N.A	N.A	3											2.16										
	87833-1436	N.A	N.A	3											3.18										
N.A	N.A	87833-7420	2	YES	N.A	YES	YES	18.65	14.00	17.00	16.85	10.00	N.A	2.16											
16	87833-1619	N.A	N.A	1	YES	N.A	YES	YES	20.65	16.00	19.00	18.85	12.00	N.A	3.18										
	87833-1620	N.A	N.A	2											2.16										
	87833-1621	N.A	N.A	3											3.18										
	87833-6120	N.A	87833-7120	2											YES	N.A	YES	YES	22.65	18.00	21.00	20.85	14.00	N.A	3.18
18	87833-1819	N.A	N.A	1	YES	N.A	YES	YES	24.65	20.00	23.00	22.85	16.00	N.A	2.16										
	87833-1820	N.A	N.A	2											3.18										
	87833-1821	N.A	N.A	3											2.16										
	87833-6220	N.A	N.A	2											YES	N.A	YES	YES	26.65	22.00	25.00	24.85	18.00	N.A	2.00
	87833-2019	N.A	N.A	1											YES	N.A	YES	YES	26.65	22.00	25.00	24.85	18.00	N.A	3.50
87833-2020	N.A	87833-7220	2	2.16																					
87833-2021	N.A	N.A	3	3.18																					
87833-6520	N.A	N.A	2	YES	N.A	YES	YES	24.65	20.00	23.00	22.85	16.00	N.A	2.16											
87833-6521	N.A	N.A	3	3.18																					
87833-2036	N.A	N.A	3	YES	N.A	YES	YES	26.65	22.00	25.00	24.85	18.00	N.A	3.27											
22	87833-2219	N.A	N.A	1	YES	N.A	YES	YES	26.65	22.00	25.00	24.85	18.00	N.A	2.16										
	87833-2220	N.A	N.A	2											3.18										
	87833-2221	N.A	N.A	3											2.16										
24	87833-2419	N.A	N.A	1	YES	N.A	YES	YES	26.65	22.00	25.00	24.85	18.00	N.A	2.16										
	87833-2420	N.A	87833-7020	2											2.00										
	87833-2421	N.A	N.A	3											3.50										
	87833-7320	N.A	N.A	2											YES	N.A	YES	YES	26.65	22.00	25.00	24.85	18.00	N.A	3.27
	87833-2436	N.A	N.A	3											YES	N.A	YES	YES	26.65	22.00	25.00	24.85	18.00	N.A	3.27
87833-6920	N.A	N.A	2	YES	N.A	YES	YES	26.65	22.00	25.00	24.85	18.00	N.A	3.27											

PLATING OPTIONS:

- 1 - 0.05-0.13um/2-5uin GOLD IN CONTACT AREA AND 1.88um/75uin MIN. MATTE TIN IN SOLDER TAIL AREA OVER 1.27um/50uin MIN. NICKEL OVERALL.
- 2 - 0.38um/15uin MIN. GOLD IN CONTACT AREA AND 1.88um/75uin MIN. MATTE TIN IN SOLDER TAIL AREA OVER 1.27um/50uin MIN. NICKEL OVERALL.
- 3 - 0.76um/30uin MIN. GOLD IN CONTACT AREA AND 1.88um/75uin MIN. MATTE TIN IN SOLDER TAIL AREA OVER 1.27um/50uin MIN. NICKEL OVERALL.

ADD 87833-7420 EC NO: S2017-0353 DRWN:GEMARLY 2016/10/19 CHKD:SCHEONG 2016/12/30 APPR:KHLIM 2016/12/30	QUALITY SYMBOLS $F_A=0$ $F_G=0$ $F_P=0$	GENERAL TOLERANCES (UNLESS SPECIFIED)		DIMENSION STYLE <b>MM ONLY</b>		SCALE NTS	DESIGN UNITS METRIC	THIRD ANGLE PROJECTION			
		4 PLACES ± --- ± ---	3 PLACES ± --- ± ---	DRAWN BY GMENARLY	DATE 2015/09/29	TITLE MILLIGRID, 2MM PITCH SHROUDED HEADER R/A, THROUGH HOLE					
		2 PLACES ± 0.20 ± ---	1 PLACE ± --- ± ---	CHECKED BY CGOH	DATE 2015/10/30	molex					
		0 PLACE ± --- ± ---	ANGULAR ± 3 °	APPROVED BY KHLIM	DATE 2015/11/03	MATERIAL NO. SEE TABLE		DOCUMENT NO. SD-87833-0001		SHEET NO. 7 OF 9	
DRAFT WHERE APPLICABLE MUST REMAIN WITHIN DIMENSIONS		THIS DRAWING CONTAINS INFORMATION THAT IS PROPRIETARY TO MOLEX INCORPORATED AND SHOULD NOT BE USED WITHOUT WRITTEN PERMISSION									

26 TO 38 CIRCUITS

CKT SIZE	ASSY P/N WITHOUT KAPTON IN TUBE	ASSY P/N WITH KAPTON IN TUBE	ASSY P/N WITH KAPTON IN T&R	PLATING OPTIONS	FRICTION LOCKS		DUAL SIDE SLOTS	CENTER POLARIZATION	DIMENSION						
					DUAL	CENTER			A	B	C	D	E	F	G (SOLDER TAIL)
26	87833-2619	N.A	N.A	1											
	87833-2620	N.A	N.A	2											
	87833-2621	N.A	N.A	3	YES	N.A	YES	YES	28.65	24.00	27.00	26.85	20.00	N.A	2.16
	87833-2636	N.A	N.A	3	YES	N.A	YES	YES							3.50
28	87833-2819	N.A	N.A	1											
	87833-2820	N.A	N.A	2											
	87833-2821	N.A	N.A	3	YES	N.A	YES	YES	30.65	26.00	29.00	28.85	22.00	N.A	2.16
	87833-6620	N.A	N.A	2	YES	N.A	YES	YES							3.18
30	87832-3019	N.A	N.A	1											
	87833-3020	N.A	N.A	2											
	87833-3021	N.A	N.A	3	YES	N.A	YES	YES	32.65	28.00	31.00	30.85	24.00	N.A	2.16
	87833-6720	N.A	N.A	2											
	87833-6721	N.A	N.A	3	YES	N.A	YES	YES							3.18
	87833-3036	N.A	N.A	3	YES	N.A	YES	YES							3.50
32	87833-3219	N.A	N.A	1											
	87833-3220	N.A	N.A	2	YES	N.A	YES	YES	34.65	30.00	33.00	32.85	26.00	N.A	2.16
	87833-3221	N.A	N.A	3											
34	87833-3419	N.A	N.A	1											
	87833-3420	N.A	N.A	2											
	87833-3421	N.A	N.A	3	YES	N.A	YES	YES	36.65	32.00	35.00	34.85	28.00	N.A	2.16
	87833-5420	N.A	N.A	2	YES	N.A	YES	YES							3.18
	87833-3424	N.A	N.A	2	N.A	N.A	YES	YES							2.92
36	87833-3619	N.A	N.A	1											
	87833-3620	N.A	N.A	2	YES	N.A	YES	YES	38.65	34.00	37.00	36.85	30.00	N.A	2.16
	87833-3621	N.A	N.A	3											
38	87833-3819	N.A	N.A	1											
	87833-3820	N.A	N.A	2	YES	N.A	YES	YES	40.65	36.00	39.00	38.85	32.00	N.A	2.16
	87833-3821	N.A	N.A	3											

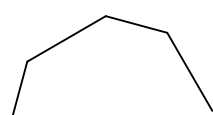

PLATING OPTIONS:

- 1 - 0.05-0.13um/2-5uin GOLD IN CONTACT AREA AND 1.88um/75uin MIN. MATTE TIN IN SOLDER TAIL AREA OVER 1.27um/50uin MIN. NICKEL OVERALL.
- 2 - 0.38um/15uin MIN. GOLD IN CONTACT AREA AND 1.88um/75uin MIN. MATTE TIN IN SOLDER TAIL AREA OVER 1.27um/50uin MIN. NICKEL OVERALL.
- 3 - 0.76um/30uin MIN. GOLD IN CONTACT AREA AND 1.88um/75uin MIN. MATTE TIN IN SOLDER TAIL AREA OVER 1.27um/50uin MIN. NICKEL OVERALL.

SEE SHEET 7&9 EC NO: S2017-0353 DRWN:GMENARLY 2016/10/19 CHKD:SCHEONG 2016/12/30 APPR:KHL IM 2016/12/30	QUALITY SYMBOLS	GENERAL TOLERANCES (UNLESS SPECIFIED)		DIMENSION STYLE	SCALE	DESIGN UNITS	THIRD ANGLE PROJECTION
	$F_A=0$	mm	INCH	MM ONLY	NTS	METRIC	
	$F_C=0$	4 PLACES ± --- ± ---	3 PLACES ± --- ± ---	DRAWN BY	DATE	TITLE	
	$F_B=0$	2 PLACES ± 0.20 ± ---	1 PLACE ± --- ± ---	GMENARLY	2015/09/29	MILLIGRID, 2MM PITCH SHROUDED HEADER R/A, THROUGH HOLE	
	0 PLACE ± --- ± ---	ANGULAR ± 3 °	DRAFT WHERE APPLICABLE MUST REMAIN WITHIN DIMENSIONS	CHECKED BY	DATE	SD-87833-0001	
		SEE TABLE		CGOH	2015/10/30	8 OF 9	
				APPROVED BY	DATE	THIS DRAWING CONTAINS INFORMATION THAT IS PROPRIETARY TO MOLEX INCORPORATED AND SHOULD NOT BE USED WITHOUT WRITTEN PERMISSION	
				KHL IM	2015/11/03		
				MATERIAL NO.	DOCUMENT NO.		



40 TO 50 CIRCUITS

CKT SIZE	ASSY P/N WITHOUT KAPTON IN TUBE	ASSY P/N WITH KAPTON IN TUBE	ASSY P/N WITH KAPTON IN T&R	PLATING OPTIONS	FRICTION LOCKS		DUAL SIDE SLOTS	CENTER POLARIZATION	DIMENSION							
					DUAL	CENTER			A	B	C	D	E	F	G (SOLDER TAIL)	
40	87833-4019	N.A	N.A	1												
	87833-4020	N.A	N.A	2	YES	N.A	YES	YES	42.65	38.00	41.00	40.85	34.00	N.A	2.16	
	87833-4021	N.A	N.A	3												
42	87833-4219	N.A	N.A	1												
	87833-4220	N.A	N.A	2	YES	N.A	YES	YES	44.65	40.00	43.00	42.85	36.00	N.A	2.16	
	87833-4221	N.A	N.A	3												
44	87833-4419	N.A	N.A	1												
	87833-4420	N.A	N.A	2	YES	N.A	YES	YES	46.65	42.00	45.00	44.85	38.00	N.A	2.16	
	87833-4421	N.A	N.A	3												
	87833-4424	N.A	N.A	2												
	87832-4425	N.A	N.A	3	N.A	N.A	YES	YES								2.92
46	87833-4619	N.A	N.A	1												
	87833-4620	N.A	N.A	2	YES	N.A	YES	YES	48.65	44.00	47.00	46.85	40.00	N.A	2.16	
	87833-4621	N.A	N.A	3												
48	87833-4819	N.A	N.A	1												
	87833-4820	N.A	N.A	2	YES	N.A	YES	YES	50.65	46.00	49.00	48.85	42.00	N.A	2.16	
	87833-4821	N.A	N.A	3												
50	87833-5019	N.A	N.A	1												
	87833-5020	N.A	N.A	2	YES	N.A	YES	YES	52.65	48.00	51.00	50.85	44.00	N.A	2.16	
	87833-5021	N.A	N.A	3												

PLATING OPTIONS:

- 1 - 0.05-0.13um/2-5uin GOLD IN CONTACT AREA AND 1.88um/75uin MIN. MATTE TIN IN SOLDER TAIL AREA OVER 1.27um/50uin MIN. NICKEL OVERALL.
- 2 - 0.38um/15uin MIN. GOLD IN CONTACT AREA AND 1.88um/75uin MIN. MATTE TIN IN SOLDER TAIL AREA OVER 1.27um/50uin MIN. NICKEL OVERALL.
- 3 - 0.76um/30uin MIN. GOLD IN CONTACT AREA AND 1.88um/75uin MIN. MATTE TIN IN SOLDER TAIL AREA OVER 1.27um/50uin MIN. NICKEL OVERALL.

CORRECT DIM G @ D1 EC NO: S2017-0353 DRWN:GMENARLY 2016/10/19 CHK:DKSCHEONG 2016/12/30 APPR:KHLIM 2016/12/30	DESCRIPTION QUALITY SYMBOLS $\nabla_A=0$ $\nabla_G=0$ $\nabla_P=0$	GENERAL TOLERANCES (UNLESS SPECIFIED)		DIMENSION STYLE MM ONLY		SCALE NTS	DESIGN UNITS METRIC	THIRD ANGLE PROJECTION		
			mm	INCH	DRAWN BY GMENARLY	DATE 2015/09/29	TITLE MILLIGRID, 2MM PITCH SHROUDED HEADER R/A, THROUGH HOLE			
					CHECKED BY CGOH	DATE 2015/10/30	 DOCUMENT NO. SD-87833-0001 SHEET NO. 9 OF 9			
					APPROVED BY KHLIM	DATE 2015/11/03				
A5	REV	DRAFT WHERE APPLICABLE MUST REMAIN WITHIN DIMENSIONS		ANGULAR $\pm 3^\circ$	SEE TABLE		MATERIAL NO.		THIS DRAWING CONTAINS INFORMATION THAT IS PROPRIETARY TO MOLEX INCORPORATED AND SHOULD NOT BE USED WITHOUT WRITTEN PERMISSION	